

*Air cooled liquid chiller with
inverter technology for outdoor
installation*

SCREWLine⁴⁻ⁱ

WDAT-iZ4 120.1 - 580.2 RANGE

TECHNICAL BULLETIN



SIZE	120.1	160.1	200.1	240.1	290.1	250.2	280.2	320.2	360.2	400.2	440.2	480.2	540.2	580.2
COOLING CAPACITY [kW]	204	256	360	420	511	423	483	540	631	711	790	881	966	1056

Page

3	Features and benefits
4	Standard unit technical specifications
7	Unit configuration
8	Built-in options
11	Accessories separately supplied
12	General technical data
18	Performances
27	Configurations
30	Accessories - Hydronic assembly
41	Arrangement of hydronic groups
42	Dimensional drawings



Clivet is taking part in the EUROVENT certification programme up to 1.500 kW. The products concerned appear in the certified products list of the EUROVENT www.eurovent-certification.com site.

Features and benefits

SCREWLine: Screw technology for an efficient and versatile product

SCREWLine is the new generation of Clivet liquid chillers with inverter Screw compression technology: high energy efficiency, great operating reliability and maximum choice versatility, with many versions and models for different types of installation.

WDAT-iZ4

Air cooled water chiller with inverter technology

- EXCELLENCE Version
- Continuous capacity control
- Seasonal efficiency 5,3
- Operating with 50°C of outdoor air temperature
- Full aluminium microchannel coils
- Partial recovery of the condensing heat



WDAT-iK4

Air cooled water chiller with inverter technology

- EXCELLENCE / PREMIUM Version
- Continuous capacity control
- Seasonal efficiency 5,3 / 4,9
- Operating with 50°C of outdoor air temperature
- Full aluminium microchannel coils
- Partial recovery of the condensing heat



WDAT-iL3

Air cooled water chiller with inverter technology

- PREMIUM compact version
- Continuous capacity control
- Seasonal efficiency 4,7
- Operating with 50°C of outdoor air temperature
- Copper aluminium condensing coils
- Partial recovery of the condensing heat

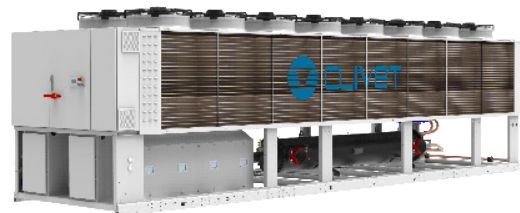

Compressor

Compact, semi hermetic, helicoidal twin-screw compressors with high efficiency integrated oil separator. The cooling capacity continuous modulation is made by a variable speed motor activated by the inverter integrated in the compressor. The start-up with limited current absorption is achieved by progressively accelerating the compressor with the inverter. The inverter is cooled with the liquid cooler taken from the liquid line. The liquid flow is activated by a solenoid valve and is sent to the inverter cooling plate by a thermostatic valve. Subsequently, the steam generated by the heat exchange is sucked by the screws inside a closed chamber at medium pressure without thereby reducing the compressor suction capacity.

The electronic boards are housed inside the inverter. They, in addition to managing the inverter and the electric motor rotation speed, perform all the functions of protection, monitoring and control of the compressor: oil level, oil temperature, motor temperature, Vi control, oil heater activation, if necessary, liquid injection for the inverter and compressor cooling, check of the operating range by specific HP and LP transducers, communication via MODBUS, operating timing, alarm management. The inverter and electric motor supply is three-phase, the auxiliaries are supplied with single phase line. At the compressor discharge is provided a non-return valve to avoid the counter-rotating during the stop. The emergency internal overpressure valve connects the compressor discharge with suction in case of an extreme pressure drop

Structure

Structure and base made entirely of sturdy sheet steel, thickness of 30/10 or 40/10, with the surface treatment in Zinc–Magnesium painted, for the parts in view, with polyester powder RAL 9001 that guarantees excellent mechanical characteristics and high corrosion strength over time.

Internal exchanger (evaporator)

Direct expansion exchanger with refrigerant side independent circuit for each compressor. The exchanger is composed of a cover made of carbon steel. The tubes, anchored to the tube plate by mechanical expansion, are made of copper, high efficiency, internally rifled to improve thermal exchange and specially designed for use with modern ecological refrigerants. It also includes a water side protection differential switch, an anti-freeze heating element to protect against icing, and covering in closed-cell thermo-insulating material that prevents the formation of condensation and heat exchange with the exterior.

The water connections of the exchanger are quick-release with splined joint (Victaulic).

External exchanger (condenser)

Full aluminium microchannel coil with V structure open angle geometry. The entire exchanger (tubes, fins and manifolds) is made of aluminum and welded into a single body through a special brazing technology in a controlled-temperature chamber. The fins have a special corrugated surface to ensure maximum heat exchange efficiency. The special flat configuration of the pipes reduces the section that opposes to the air flow, limiting the pressure drops and maximizing the surface. The total refrigerant charge into the microchannel coil is reduced by 30% compared to an equivalent copper coil.

Fan

Axial fans with high performance and low-noise, balanced statically and dynamically, with blades in aluminum sheet coated in PP and sickle profile terminating with "Winglets", Wall ring in sheet steel pre-galvanised, directly coupled to the three-phase electric motor with external rotor and IP54 protection and class F insulation. Fans are located in aerodynamically shaped structures, equipped with accident prevention steel guards. Supplied with variable speed control (ECOBREEZE).

Refrigeration circuit

One or two independent refrigeration circuits made of copper, brazed and factory-assembled, complete with:

- anti-acid dehydrator filter with solid cartridge complete with quick-fit connector for refrigerant;
- high-pressure safety pressure switch;
- low pressure transducer;
- refrigerant temperature probe;
- electronic expansion valve;
- high pressure safety valve (safety valve with sealed tap open for inspection);
- double low pressure safety valve (safety valve with sealed tap open for inspection);
- liquid flow and humidity indicator;
- cut-off valve on compressor supply circuit;
- cut-off valve on liquid line.

Suction pipes thermally insulated with highly flexible EPDM rubber closed-cell elastomer insulation. Each cooling circuit is tested under pressure for leaks and is supplied complete with load of refrigerant gas.

Electrical panel

Entirely manufactured and wired in conformity to the EN 60204 standard.

The power section includes:

- door locking main circuit breaker;
- insulation transformer for powering the auxiliary circuit;
- fuses and thermal relays for protecting the compressors;
- magneto-thermal cut-out switches to protect fans;
- electrical panel ventilation.

The control section includes:

- proportional-integral-derivative adjustment of water temperature;
- anti-freeze protection;
- management of unit start-up from local or remote device (serial);
- compressor overload protection and timer;
- potential-free contacts for compressor status and enabling;
- self-diagnosis system with instant error code visualisation;
- pre-alarm function for water anti-frost and refrigerant gas high pressure functions;
- visualisation of no. of hours of compressor operation;
- interface terminal with graphic display;
- multifunction phase monitor;
- remote ON/OFF control;
- second set-point enabling by potential-free contact;
- control of compressor start-up automatic rotation;
- relay for remote cumulative fault signal;
- set values, error codes and parameters can be displayed;
- high refrigerant gas pressure pre-alarm function that in many cases prevents the unit from being shut-down;
- input for demand limit (absorbed power limit according to an external signal 0÷10V or 4÷20mA);
- electrical socket (max 400W)

Standard unit technical specifications

Accessories

- Protection grilles and compressor compartment
- Energy meter
- Set-point compensation with outdoor air temperature probe
- Set point compensation with 0-10 V signal
- Serial communication module for Modbus supervisor
- Serial communication module for LonWorks supervisor
- Serial communication module for BACnet-IP supervisor
- Inverter driven variable flow-rate user side control depending on the temperature differential
- Refrigerant leak detector assembled on the casing (available only with SC and EN configuration)
- Remote control via microprocessor control (separately supplied accessories)
- Electrical panel antifreeze protection for min. outdoor temperature down to -25°C
- Spring antivibration mounts (separately supplied accessories)
- Anti-seismic spring antivibration mounts (separately supplied accessories)
- Couple of manually operated shut-off valves (separately supplied accessories)
- Steel mesh strainer on the water side (separately supplied accessories)
- Mains power supply (separately supplied accessories)
- High and low pressure gauges
- Microchannel coils protection panels
- E-coated microchannel coil
- Ecoshare function for the automatic management of a group of units
- EMC filtering to reduce conducted compressor emissions
- Switching valve with double safety valves
- Device for the condensing coil partialization

Test

All the units are factory-tested in specific steps, before shipping them.

Unit equipment with outdoor air low temperatures

MINIMUM OUTDOOR AIR TEMPERATURE		OPERATING UNIT	UNIT IN STAND-BY ⁽⁵⁾ (fed unit)	UNIT IN STORAGE (unit not fed)
+11°C	1	✓ STANDARD UNIT	✓ STANDARD UNIT	✓ STANDARD UNIT
+2°C	2			
-7°C	3			
-10°C	4			
Between -10 °C and -15 °C		✓ UNIT + REGBT OPTION	✓ UNIT + REGBT OPTION ✓ GLYCOL IN AN APPROPRIATE PERCENTAGE	✓ UNIT + REGBT OPTION ⁽⁶⁾
Between -15°C and -18°C		✓ UNIT + REGBT OPTION	✓ UNIT + REGBT OPTION WATER EMPTY UNIT ✓ ELECTRICAL PANEL ANTIFREEZE PROTECTION (RE-25) ✗ NOT SUITABLE: BUILT-IN PUMPS	NOT POSSIBLE

Data referred to the following conditions:
 - internal exchanger water = 12/7°C

1. Part load unit and air speed equal to 1 m/s.
2. Part load unit and air speed equal to 0.5 m/s.
3. Part load unit and outdoor air temperature at rest.
4. Unit at full load and outdoor air temperature at rest.

⁽⁵⁾ The water pumping unit must be fed and connected to the unit according to the manual.

⁽⁶⁾ Unit without water or containing water with an appropriate quantity of glycol.

At the unit start-up the water temperature or water with glycol must be inside the operating range indicated in the "Operating range" graph. To know the water freezing temperature on varying the glycol percentage refer to the specific 'Correction factors for glycol use' table.

⚠ Air conditions which are at rest are defined as the absence of air flowing towards the unit. Weak winds can induce air to flow through the exchanger and air-levels which can cause a reduction in the operating range. In the presence of predominant winds it is necessary to use suitable windbreak barriers.

Minimum system water content

For a proper functioning of the unit a minimum water content has to be provided to the system, using the formula:

$$\begin{aligned} \text{Minimum water content for comfort application [liters]} &= 13 \times \text{kWf (sizes 120.1 - 290.1)} \\ &= 5 \times \text{kWf (sizes 250.2 - 580.2)} \end{aligned}$$

$$\begin{aligned} \text{Minimum water content for process application [liters]} &= 26 \times \text{kWf (sizes 120.1 - 290.1)} \\ &= 10 \times \text{kWf (sizes 250.2 - 580.2)} \end{aligned}$$

kWf = Nominal cooling capacity unit

⚠ Volume calculated does not consider internal heat exchanger (evaporator) water content.

Unit configuration

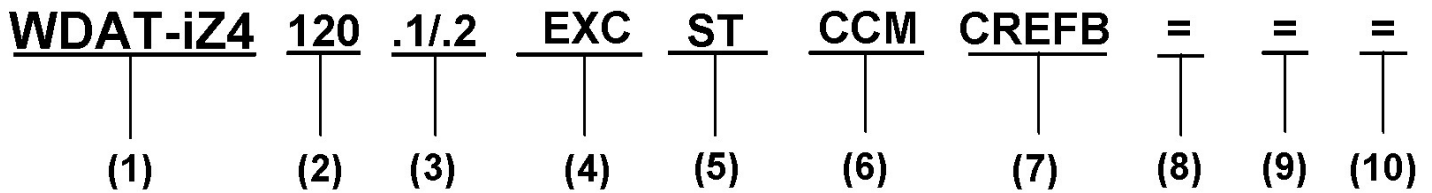

(1) Range

WDAT = Air cooled liquid chiller

IZ4 = SCREWLine³-i range with inverter driver screw compressor and R1234ze refrigerant

(2) Size

120 = Nominal compressor capacity (HP)

(3) Compressor

.1 / .2 = Compressor quantity

(4) Energy efficiency

EXC = EXCELLENCE Version

(5) Acoustic configuration

ST = Standard acoustic configuration (standard)

SC = Acoustic configuration with compressor soundproofing

EN = Super-silenced acoustic configuration

(6) Condensing coil

CCM = Aluminum microchannel condensing coils (Standard)

CCME = E-coated microchannel coil

(7) Fans

CREFB = Device for fan consumption reduction of the external section ECOBREEZE type (Standard)

(8) Low evaporator water temperature configuration

(-) Low water temperature: not required (standard)

B = Low water temperature, down to -2°C (Brine)

(9) Condensation heat recovery

(-) Recovery not required (standard)

D = Partial energy recovery

(10) Hydronic assemblies

(-) Not required (standard)

1PM = Hydropack with N° 1 pump

1PMH = Hydropack with N° 1 high static pressure pump

1PMV = Hydropack with N° 1 inverter pump

1PMVH = Hydropack with N° 1 high static pressure inverter pump

2PM = Hydropack with N° 2 pumps

2PMH = Hydropack with N° 2 high static pressure pumps

2PMV = Hydropack with N° 2 inverter pumps

2PMVH = Hydropack with N° 2 high static pressure inverter pumps

PGCC

Finned coil protection grilles and compressor compartment

This accessory is used to protect the external coil from the accidental contact with external things or people.
Ideal for installation in places where persons can pass from, such as car parks, terraces, etc.
The accessory is provided and installed built-in the unit. Grille slot 25 mm.



- ⚠ This option is not suitable for application in sulphuric environments.
- ⚠ Option available only in combination with microchannel coils protection panels (PPBM)

CMSC9

Serial communication module for Modbus supervisor

This enables the serial connection of the supervision system, using Modbus as the communication protocol. It enables access to the complete list of operational variables, commands and alarms. Using this accessory every unit can dialogue with the main supervision systems.

The device is installed and wired built-in the unit.

- ⚠ The total length of each serial line do not exceed 1000 meters and the line must be connected in bus typology (in/out)

CMSC10

Serial communication module for LonWorks supervisor

This enables the serial connection of the supervision system which uses the LonWorks communication protocol. It enables access to a list of operating variables, commands and alarms which comply with the Echelon® standard.

The device is installed and wired built-in the unit.

- ⚠ The configuration and management activities for the LonWorks networks are the responsibility of the client.
- ⚠ LonWorks technology uses the LonTalk® protocol for communicating between the network nodes. Contact the service supplier for further information.
- ⚠ The total length of each serial line do not exceed 1000 meters and the line must be connected in bus typology (in/out)

CMSC11

Serial communication module for BACnet/IP supervisor

This enables the serial connection of the supervision system, using BACnet/IP as the communication protocol. It enables access to the complete list of operational variables, commands and alarms. Using this accessory every unit can dialogue with the main supervision systems.

The device is installed and wired built-in the unit.

- ⚠ The configuration and management activities for the BACnet networks are the responsibility of the client.
- ⚠ The total length of each serial line do not exceed 1000 meters and the line must be connected in bus typology (in/out)

CONTA2

Energy meter

Allows to display and record the unit's main electrical parameters. The data can be displayed with the user interface on the unit or via the supervisor through the specific protocol variables.

It is possible to control:

- voltage (V),
- absorbed current (A),
- frequency (Hz),
- cosfi,
- power input (kW),
- absorbed energy (kWh),
- harmonic components (%)

The device is installed and wired built-in the unit.

SCP4

Set-point compensation with 0-10 V signal

This device enables the set-point to be varied which is pre-set using an external 0÷10 V signal.
The device is installed and wired built-in the unit.

SPC2

Set-point compensation with outdoor air temperature probe

This device enables the set-point to be varied automatically which is pre-set depending on the outdoor air temperature. This device enables the liquid flow temperature to be obtained, which varies depending on external conditions, enabling energy savings throughout the entire system.

The device is installed and wired built-in the unit.

- ⚠ The device includes a probe controlled remotely from outside to measure the outdoor air temperature (installation to be carried out by the customer). The connection cable length is 16 m.

Built-in options

CCME

E-coated microchannel coil

The full aluminium microchannel coil is completely treated by electrolysis so as to create a protective layer of epoxy polymer on the surface, with the following characteristics:

- over 3000 hours of protection against salt spray (ASTM G85 A3 - SWAAT);
- over 2000 hours of protection against UV rays (ASTM G155-05a)
- provide a very high resistance against corrosion.

IVFDT

Inverter driven variable flow-rate user side control depending on the temperature differential

This option allows water flow-rate modulation to the unit during partial load conditions, maintaining stable the temperature difference between inlet and outlet to the heat exchanger. Flow regulation is managed by the on-board electronics through the water temperature probes integrated on the unit. With no building load the unit switches off the compressors while concerning pumps is possible to select:

- Active pumps with minimum flow-rate, monitoring secondary circuit temperature variations
- Pump switching off, periodically activating them (settable time) leading secondary circuit temperatures on primary circuit
- Pump switching off and waiting for the user signal for activation (free potential)

Flow-rate modulation is managed by embedded logic thanks to built-in flow-rate control device and temperature probes. This device is installed and wired.

⚠ Option available only with inverter pumps installed on board (1PMV / 2PMV).

RE-25

Electrical panel antifreeze protection for min. outdoor temperature down to -25°C

This option is necessary for very cold climates, where the external temperature can go down to -25°C. It includes self-regulating temperature maintaining resistances which are able to protect the electrical panel against condensation and frost guaranteeing that it functions correctly. The choice of device should be carried out on the basis of the minimum temperatures reached at the unit installation site.

The device is built-in the unit.

⚠ It is necessary to make precautions against build up of snow and ice in front of the exhaust and outdoor air inlet locations

⚠ This accessory operates even when the unit is switched off provided that the power supply is maintained active and the unit continues to be connected.

⚠ This accessory does not lead to substantial variations in the electrical data for the unit which has been declared in the Electrical Data section.

FC2

EMC filtering to reduce conducted compressor emissions

The EMC filtering device, installed and wired on board the machine, reduces electromagnetic interference and makes the unit compliant with the immunity and industrial emission requirements in accordance with the EN 61000-6-2 and EN 61000-6-4 standards.

PPBM

Microchannel coils protection panels

Microchannel coils protection panels supplied on the manifold side.

They guarantee greater protection during transport and from accidental contact with things or people.

MHP

High and low pressure gauges

It includes two liquid pressure gauges for the analog measurement of refrigerant pressures on suction and discharge lines of the compressors with pressure sockets installed in the unit in an easily accessible location.

The accessory is built-in the unit. .

RPRI

Refrigerant leak detector assembled on the casing

Leak detector device built-in installed and placed inside the compressor box, it detects leaks of the internal refrigeration circuit.

⚠ Option available only whit acoustic configuration with compressor soundproofing (SC) and Super-silenced version (EN)

ECS	<p>ECOSHARE function for the automatic management of a group of units</p> <p>The device allows automatic management of units that operate on the same hydraulic circuit, by creating a local communication network.</p> <p>There are two control modes that can be set via a parameter during the activation stage. They both distribute the heat load on the available units by following the distribution logic to benefit from efficiency levels at part load.</p> <p>Moreover:</p> <p>Mode 1 - it keeps all the pumps active</p> <p>Mode 2 - it activates only the pumps of the unit required to operate</p> <p>The device allows for rotation based on the criterion of minimum wear and management of units in stand-by. There are various unit sizes. Every unit must be fitted with the ECOSHARE feature. The set of units is controlled by a Master unit. The local network can be extended up to 7 units (1 Master and 6 Slave).</p> <p> The unit supplied with this device can also be equipped at the same time with the RCMRX option and one of the CMSC9 / CMSC10 / CMSC11 options.</p>
RDVS	<p>Double safety valves with changeover valve</p> <p>Allows maintenance or replacement of the safety valve without draining the unit. Two pressure relief valves (each valve is sized according to 13136 clause 6.2) connected via a changeover valve are provided.</p>
REGBT	<p>Device for the condensing coil partialization</p> <p>Electronic device supplied on the unit allows to extend the unit operating range in cooling down to an outdoor air temperature of -18°C. For good operation of the unit at low outdoor temperatures, the fan motors speed is continuously adjusted as well as the finned exchange surface according to the ambient temperature.</p>

Accessories separately supplied

RCMRX

Remote control via microprocessor control

This option allows to have full control over all the unit functions from a remote position. It can be easily installed on the wall and has the same aspect and functions of the user interface on the unit.

- ⚠ All device functions can be repeated with a normal portable PC connected to the unit with an Ethernet cable and equipped with an internet navigation browser.
- ⚠ The device must be installed on the wall with suitable plugs and connected to the unit (installation and wiring to be conducted by the Customer). Maximum remote control distance 350 m without auxiliary power supply. For distances greater than 350 m and in any case less than 700 m it is necessary to install the 'PSX - Mains power unit' accessory.
- ⚠ Data and power supply serial connection cable n.1 twisted and shielded pair. Diameter of the individual conductor 0.8 mm.
- ⚠ Installation is a responsibility of the Customer.

AMMX

Spring antivibration mounts

The spring antivibration mounts are attached in special housing on the support frame and serve to smooth the vibrations produced by the unit thus reducing the noise transmitted to the support structure.

- ⚠ Installation is a responsibility of the Customer.

AMMSX

Anti-seismic spring antivibration mounts

The anti-seismic spring antivibration mounts must be fastened in special housings on the supporting metal struts. The containment structure is designed to ensure high resistance multidirectional forces acting on the surface of the unit in the presence of wind and / or telluric movements. The antivibration mounts have been tested according to ANSI/ASHRAE 171-2008 standard (Method of Testing Seismic Restraint devices for HVAC&R Equipment). The performance levels and the test methodology have been validated and certified by Lloyd's Register.

- ⚠ Installation is a responsibility of the Customer.

IFWX

Steel mesh strainer on the water side

The device stops the exchanger from being clogged by any impurities which are in the hydraulic circuit. The mechanical steel mesh strainer must be placed on the water input line. It can be easily dismantled for periodical maintenance and cleaning. It also includes:

- cast-iron shut-off butterfly valve with quick connections and activation lever with a mechanical calibration lock;
- quick connections with insulated casing.

- ⚠ Pressure drop referred to a clean filter.
- ⚠ Installation is the responsibility of the Client, externally to the unit.
- ⚠ Check for the presence of the required hydraulic shut-off valves in the system, in order to undertake periodical maintenance.

CSVX

Couple of manually operated shut-off valves

The kit allows to isolated the input and output water circuit. It includes:

- no. 2 of cast-iron shut-off butterfly valves with fast fittings and activation lever with a mechanical setting lock
- no. 2 of victaulic connections

- ⚠ Installation is a responsibility of the Customer, outside the unit.

PSX

Mains power supply

The device allows the unit and the remote control to communicate with the user interface even when the serial line is longer than 350 m.

It must be connected to the serial line at a distance of 350 m from the unit and allows to extend the length to 700 m maximum in total. The device requires an external power supply at 230V AC.

- ⚠ Power supply at 230V AC provided by Customer.
- ⚠ Installation is a responsibility of the Customer.

Performance

Standard acoustic configuration (ST) / Compressor soundproofing (SC)

SIZE		120.1	160.1	200.1	240.1	290.1	250.2	280.2	320.2	360.2	400.2	440.2	480.2	540.2	580.2
Cooling capacity	1 [kW]	204	256	360	420	511	423	483	540	631	711	790	881	966	1056
Compressor power input	1 [kW]	59,1	79,6	107	134	156	123	145	169	198	227	246	285	303	326
Total power input	2 [kW]	64,0	84,5	114	141	165	133	154	178	210	239	260	298	319	344
Partial recovery heating capacity	3 [kW]	26,3	33,6	46,7	55,4	66,7	54,6	62,8	70,9	82,9	93,8	104	117	127	138
EER	1 -	3,20	3,03	3,15	2,99	3,09	3,18	3,13	3,03	3,01	2,98	3,04	2,95	3,03	3,07
Water flow-rate (User Side)	1 [l/s]	9,8	12,2	17,2	20,1	24,4	20,2	23,1	25,8	30,1	34,0	37,8	42,1	46,2	50,5
Internal exchanger pressure drops	1 [kPa]	35,0	42,7	39,2	42,7	49,2	38,5	36,0	46,7	52,9	47,8	51,9	46,3	52,9	47,7
Cooling capacity (EN14511:2018)	4 [kW]	204	256	360	420	510	422	482	540	630	710	790	880	965	1055
Total power input (EN14511:2018)	4 [kW]	64,7	85,4	115	142	167	134	156	180	212	241	263	301	322	348
EER (EN14511:2018)	4	3,16	3,00	3,12	2,95	3,05	3,15	3,10	3,00	2,97	2,94	3,00	2,92	3,00	3,03
SEER	6	5,15	5,13	5,17	5,14	5,20	5,42	5,38	5,36	5,42	5,37	5,39	5,37	5,33	5,35
SEPR	6	6,45	5,67	5,78	5,76	5,56	6,41	5,99	5,64	5,91	5,53	5,53	5,80	5,70	5,54
Cooling capacity (AHRI 550/590)	5 [kW]	204	256	360	420	511	423	483	540	631	711	790	881	966	1056
Total power input (AHRI 550/590)	5 [kW]	63,9	84,5	114	141	165	133	154	178	210	239	260	298	319	344
COP _r	5	3,19	3,03	3,16	2,98	3,10	3,18	3,14	3,03	3,00	2,97	3,04	2,96	3,03	3,07
IPLV	5 -	5,90	5,93	5,55	5,56	5,85	5,73	5,80	5,69	5,75	5,60	5,78	5,49	5,70	5,69

The Product is compliant with the Erp (Energy Related Products) European Directive. It includes the Commission delegated Regulation (EU) No 2016/2281, also known as Ecodesign LOT21. Contains fluorinated greenhouse gases (GWP < 1)

1. Data referred to the following conditions: internal exchanger water temperature = 12/7 °C. Entering external exchanger air temperature = 35°C. Evaporator fouling factor = 0.44 x 10⁽⁻⁴⁾ m² K/W.
2. The Total Power Input value does not take into account the part related to the pumps and required to overcome the pressure drops for the circulation of the solution inside the exchangers.
3. Recovery exchanger water = 40/45°C
4. Data compliant to Standard EN 14511:2018 referred to the following conditions: internal exchanger water temperature = 12/7°C. Entering external exchanger air temperature = 35°C
5. Data compliant to Standard AHRI 550/590 referred to the following conditions: internal exchanger water temperature = 6,7 °C. Water flow-rate 0,043 l/s per kW. Entering external exchanger air temperature = 35°C. Evaporator fouling factor = 0.18 x 10⁽⁻⁴⁾ m² K/W
6. Data compliant according to EU regulation 2016/2281

Configurazione acustica Supersilenziata (EN)

GRANDEZZE		120.1	160.1	200.1	240.1	290.1	250.2	280.2	320.2	360.2	400.2	440.2	480.2	540.2	580.2
Cooling capacity	1 [kW]	204	256	360	420	495	423	483	540	631	711	790	881	966	1056
Compressor power input	1 [kW]	59	80	107	134	145	123	145	169	198	227	246	285	303	326
Total power input	2 [kW]	64	84	114	140	154	133	154	178	210	238	260	298	318	344
Partial recovery heating capacity	3 [kW]	26,3	33,6	46,7	55,4	64,0	54,6	62,8	70,9	82,9	93,8	104	117	127	138
EER	1 -	3,21	3,05	3,16	3,00	3,21	3,19	3,13	3,04	3,01	2,98	3,04	2,95	3,03	3,07
Water flow-rate (User Side)	1 [l/s]	9,8	12,2	17,2	20,1	23,7	20,2	23,1	25,8	30,1	34,0	37,8	42,1	46,2	50,5
Internal exchanger pressure drops	1 [kPa]	35,0	42,7	39,2	42,7	49,2	38,5	36,0	46,7	52,9	47,8	51,9	46,3	52,9	47,7
Cooling capacity (EN14511:2018)	4 [kW]	204	256	360	420	494	422	482	540	630	710	790	880	965	1055
Total power input (EN14511:2018)	4 [kW]	64,4	85,2	115	142	155	134	155	180	212	241	263	301	322	348
EER (EN14511:2018)	4	3,16	3,01	3,12	2,96	3,18	3,15	3,10	3,00	2,97	2,95	3,00	2,92	3,00	3,04
SEER	6	5,15	5,13	5,17	5,14	5,30	5,42	5,38	5,36	5,42	5,37	5,39	5,37	5,33	5,35
SEPR	6	6,45	5,67	5,78	5,76	5,65	6,41	5,99	5,64	5,91	5,53	5,53	5,80	5,70	5,54
Cooling capacity (AHRI 550/590)	5 [kW]	204	256	360	420	495	423	483	540	631	711	790	881	966	1056
Total power input (AHRI 550/590)	5 [kW]	63,9	84,5	114	141	154	133	154	178	210	239	260	298	319	344
COP _r	5	3,19	3,03	3,16	2,98	3,21	3,18	3,14	3,03	3,00	2,97	3,04	2,96	3,03	3,07
IPLV	5 -	5,90	5,93	5,55	5,56	6,01	5,73	5,80	5,69	5,75	5,60	5,78	5,49	5,70	5,69

The Product is compliant with the Erp (Energy Related Products) European Directive. It includes the Commission delegated Regulation (EU) No 2016/2281, also known as Ecodesign LOT21. Contains fluorinated greenhouse gases (GWP < 1)

1. Data referred to the following conditions: internal exchanger water temperature = 12/7 °C. Entering external exchanger air temperature = 35°C. Evaporator fouling factor = 0.44 x 10⁽⁻⁴⁾ m² K/W.
2. The Total Power Input value does not take into account the part related to the pumps and required to overcome the pressure drops for the circulation of the solution inside the exchangers.
3. Recovery exchanger water = 40/45°C
4. Data compliant to Standard EN 14511:2018 referred to the following conditions: internal exchanger water temperature = 12/7°C. Entering external exchanger air temperature = 35°C
5. Data compliant to Standard AHRI 550/590 referred to the following conditions: internal exchanger water temperature = 6,7 °C. Water flow-rate 0,043 l/s per kW. Entering external exchanger air temperature = 35°C. Evaporator fouling factor = 0.18 x 10⁽⁻⁴⁾ m² K/W
6. Data compliant according to EU regulation 2016/2281

General technical data

Construction

Standard acoustic configuration (ST) / Compressor soundproofing (SC) / Super-silenced (EN)

SIZE		120.1	160.1	200.1	240.1	290.1	250.2	280.2	320.2	360.2	400.2	440.2	480.2	540.2	580.2
Compressor															
Type of compressors	1	ISW													
Refrigerant		R-1234ze													
No. of compressors	[Nr]	1	1	1	1	1	2	2	2	2	2	2	2	2	2
Rated power (C1)	[HP]	120	160	200	240	290	125	125	160	120	160	160	240	240	290
Rated power (C2)	[HP]	-	-	-	-	-	125	160	160	240	240	290	240	290	290
Std Capacity control steps		STEPLESS													
Oil charge (C1)	[l]	18	18	35	35	35	18	18	18	18	18	18	35	35	35
Oil charge (C2)	[l]	-	-	-	-	-	18	18	18	35	35	35	35	35	35
Refrigerant charge (C1)	[kg]	43	47	68	74	88	43	45	46	44	46	37	76	76	84
Refrigerant charge (C2)	[kg]	-	-	-	-	-	37	39	40	65	69	77	64	64	75
Refrigeration circuits	[Nr]	1	1	1	1	1	2	2	2	2	2	2	2	2	2
Internal exchanger (evaporator)															
Type of internal exchanger	2	S&T													
N. of internal exchanger	[Nr]	1	1	1	1	1	1	1	1	1	1	1	1	1	1
Water content	[l]	160	219	382	365	292	310	301	292	553	536	581	506	537	1027
External exchanger (condenser)															
Type of external exchanger	3	CCM													
N. coils	[Nr]	4	4	6	6	8	8	8	8	10	10	12	12	14	16
External Section Fans															
Type of fans	4	AX													
Number of fans		4	4	6	6	8	8	8	8	10	10	12	12	14	16
Type of motor	5	EC													
Standard airflow	[l/s]	21667	21667	32500	32500	43333	43333	43333	43333	54167	54167	65000	65000	75833	86667
Connections															
Water fittings		6"	6"	6"	6"	6"	6"	6"	6"	8"	8"	8"	8"	8"	8"
Power supply															
Standard power supply		400/3~/50													
Electrical data															
F.L.A. - Total	[A]	182,3	228,0	337,9	402,9	459,0	364,3	410,0	455,7	584,9	630,6	702,5	805,5	877,3	949,2
F.L.I. - Total	[kW]	112,2	142,5	209,7	251,7	295,2	224,2	254,5	284,8	363,7	394,0	437,5	503,2	546,7	590,2
M.I.C. - Value	[A]	182,3	228,0	337,9	402,9	459,0	364,3	410,0	455,7	584,9	630,6	702,5	805,5	877,3	949,2

1. ISW = Double screw compressor
2. S&T = Shell and tube
3. CCM = Full aluminium microchannel coils
4. AX = Axial fan
5. EC = Asynchronous motor with permanent magnet commuted electronically.
6. M.I.C.= Maximum unit starting current. The M.I.C. value is obtained adding the max. compressor starting current of the highest size to the power input at max. admissible conditions (F.L.A.) of the remaining electric components.

Unbalance between phase max 2 %

Voltage variation: max +/- 10%

Electrical data refer to standard units; according to the installed accessories, the data can suffer some variations.

Sound levels

Standard acoustic configuration (ST)

SIZE	Sound power level (dB) - Octave band (Hz)								Sound pressure level	Sound power level
	63	125	250	500	1000	2000	4000	8000	dB(A)	dB(A)
120.1	74	72	72	84	95	91	80	66	77	97
160.1	81	80	76	88	93	93	82	66	78	97
200.1	82	73	83	91	93	91	86	75	77	97
240.1	86	89	79	87	94	89	89	73	77	97
290.1	69	74	78	93	92	95	88	75	78	99
250.2	68	71	74	85	98	89	76	61	78	99
280.2	75	79	78	90	99	91	78	63	80	100
320.2	78	82	81	93	99	94	80	64	81	101
360.2	80	88	81	90	100	90	85	68	80	101
400.2	82	90	83	93	101	93	86	69	81	102
440.2	77	81	84	98	100	96	86	72	81	103
480.2	85	93	85	93	102	91	89	72	81	103
540.2	81	90	85	97	101	95	88	73	81	103
580.2	68	79	85	100	100	98	89	75	82	104

Sound levels refer to full load units, in test nominal conditions. The sound pressure level refers to 1 m. from the standard unit outer surface operating in open field. Measures according to UNI EN ISO 9614-2 regulations, with respect to the EUROVENT 8/1 certification, which provides for a tolerance of 3 dB(A).

Data referred to the following conditions:
 - internal exchanger water temperature = 12/7 °C
 - ambient temperature = 35 °C

Acoustic configuration with compressor soundproofing (SC)

SIZE	Sound power level (dB) - Octave band (Hz)								Sound pressure level	Sound power level
	63	125	250	500	1000	2000	4000	8000	dB(A)	dB(A)
120.1	67	68	70	79	91	87	78	64	74	93
160.1	74	76	76	83	89	90	79	65	74	94
200.1	75	70	83	85	90	89	83	74	74	94
240.1	80	86	79	83	91	86	86	72	74	94
290.1	62	72	78	88	89	92	85	74	75	96
250.2	62	69	73	82	95	86	74	60	75	96
280.2	68	75	78	85	96	89	76	62	76	97
320.2	72	79	82	88	97	91	78	64	78	98
360.2	73	85	81	85	97	87	82	67	77	98
400.2	76	87	83	88	98	90	83	68	78	99
440.2	71	79	84	93	98	94	83	71	78	100
480.2	78	90	85	89	99	89	86	71	78	100
540.2	75	87	84	92	98	92	85	72	78	100
580.2	61	76	85	95	98	95	86	74	79	101

Sound levels refer to full load units, in test nominal conditions. The sound pressure level refers to 1 m. from the standard unit outer surface operating in open field. Measures according to UNI EN ISO 9614-2 regulations, with respect to the EUROVENT 8/1 certification, which provides for a tolerance of 3 dB(A).

Data referred to the following conditions:
 - internal exchanger water temperature = 12/7 °C
 - ambient temperature = 35 °C

General technical data

Super-silenced acoustic configuration (EN)

SIZE	Sound power level (dB) - Octave band (Hz)								Sound pressure level	Sound power level
	63	125	250	500	1000	2000	4000	8000	dB(A)	dB(A)
120.1	66	67	71	81	86	82	76	62	69	89
160.1	74	75	77	87	86	84	77	64	71	90
200.1	72	67	82	86	86	84	78	69	70	90
240.1	78	84	79	85	86	83	80	68	70	90
290.1	61	69	78	91	86	86	80	71	71	92
250.2	61	67	75	84	91	82	73	59	72	92
280.2	67	74	79	88	91	83	74	60	72	93
320.2	71	77	82	91	92	84	75	61	73	94
360.2	72	82	81	87	92	83	76	64	72	94
400.2	75	85	85	92	94	86	78	66	75	96
440.2	69	76	84	95	93	86	78	67	75	96
480.2	77	87	85	91	94	86	80	67	74	96
540.2	73	83	84	94	93	86	79	68	74	96
580.2	58	71	83	95	92	86	78	68	74	96

Sound levels refer to full load units, in test nominal conditions. The sound pressure level refers to 1 m. from the standard unit outer surface operating in open field. Measures according to UNI EN ISO 9614-2 regulations, with respect to the EUROVENT 8/1 certification, which provides for a tolerance of 3 dB(A).

Data referred to the following conditions:
 - internal exchanger water temperature = 12/7 °C
 - ambient temperature = 35 °C

Correction factors for ethylene glycol use

% ETHYLENE GLYCOL BY WEIGHT		5%	10%	15%	20%	25%	30%	35%	40%	45%	50%
Freezing temperature	°C	-2,0	-3,9	-6,5	-8,9	-11,8	-15,6	-19,0	-23,4	-27,8	-32,7
Safety temperature	°C	3,0	1,0	-1,0	-4,0	,6,0	-10,0	-14,0	-19,0	-23,8	-29,4
Cooling Capacity Factor	kW	0,995	0,989	0,983	0,977	0,971	0,964	0,956	0,949	0,941	0,933
Compressor power input Factor	kW	0,998	0,997	0,995	0,994	0,992	0,990	0,989	0,987	0,986	0,984
Internal exchanger pressure drop factor	kW	1,041	1,085	1,131	1,180	1,231	1,285	1,341	1,400	1,461	1,525

Correction factors for propylene glycol use

% PROPYLENE GLYCOL BY WEIGHT		5%	10%	15%	20%	25%	30%	35%	40%	45%	50%
Freezing temperature	°C	-2,0	-3,9	-6,5	-8,9	-11,8	-15,6	-19,0	-23,4	-27,8	-32,7
Safety temperature	°C	3,0	1,0	-1,0	-4,0	,6,0	-10,0	-14,0	-19,0	-23,8	-29,4
Cooling Capacity Factor	kW	0,993	0,985	0,977	0,968	0,958	0,947	0,936	0,925	0,912	0,899
Compressor power input Factor	kW	0,998	0,995	0,993	0,990	0,987	0,983	0,980	0,976	0,972	0,968
Internal exchanger pressure drop factor	kW	1,052	1,108	1,170	1,237	1,309	1,386	1,467	1,554	1,646	1,743

Fouling Correction Factors

INTERNAL EXCHANGER (EVAPORATOR)

m2 °C/W	F1	FK1
0,44 x 10 (-4)	1,0	1,0
0,88 x 10 (-4)	0,97	0,99
1,76 x 10 (-4)	0,94	0,98

F1 = Cooling capacity correction factors
FK1 = Compressor power input correction factor

Exchanger operating range

INTERNAL EXCHANGER (EVAPORATOR)

	DPR	DPW
PED (CE)	2400	1000

DPr = Maximum operating pressure on refrigerant side in kPa
DPw = Maximum operating pressure on water side in kPa

Overload and control device calibrations

		APRE	CHIUDE	VALORE
High pressure switch	[kPa]	1900	1400	-
Antifreeze protection	[°C]	3	5,5	-
High pressure safety valve	[kPa]	-	-	2400
Low pressure safety valve	[kPa]	-	-	1500
Max no. of compressor starts per hour	[n°]	-	-	6
Discharge safety thermostat	[°C]	-	-	120

General technical data

Operating range

Standard acoustic configuration (ST)

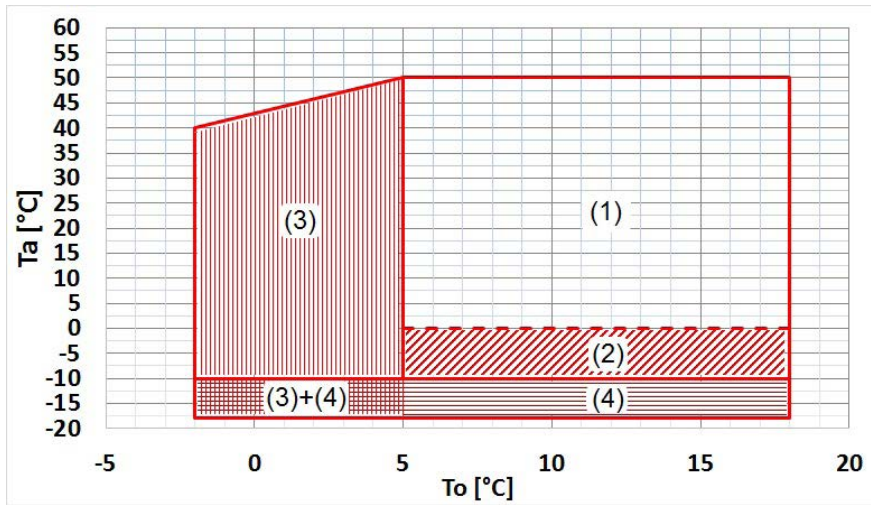

Ta (°C) = external exchanger inlet air temperature (D.B.)
To (°C) = internal exchanger outlet water temperature

1. Standard unit operating range at full load
2. Standard unit operating range with air flow automatic modulation
3. Unit operating range in "B - Low water temperature, down to -2°C (Brine)"
4. Unit operating range with "REGTB - Device for the condensing coil partialization"

Acoustic configuration: compressor soundproofing (SC) / Super-silenced (EN)

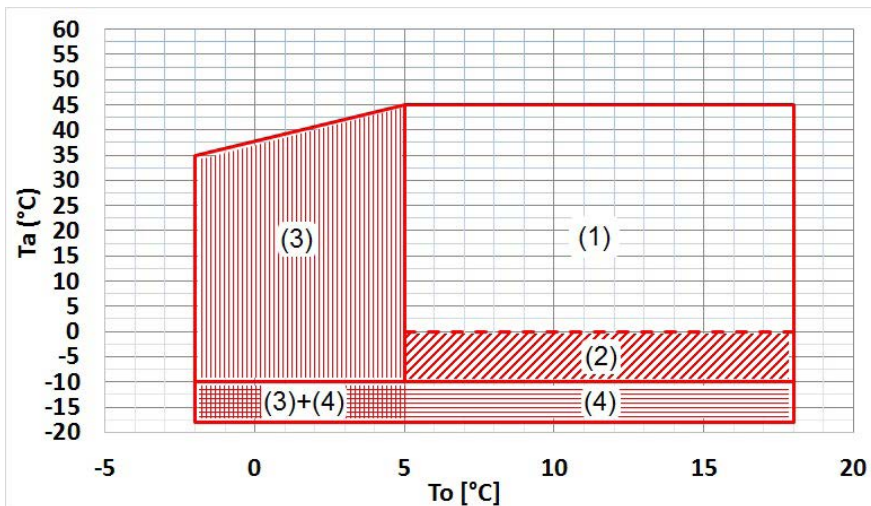

Ta (°C) = external exchanger inlet air temperature (D.B.)
To (°C) = internal exchanger outlet water temperature

1. Standard unit operating range at full load
2. Standard unit operating range with air flow automatic modulation
3. Unit operating range in "B - Low water temperature, down to -2°C (Brine)"
4. Unit operating range with "REGTB - Device for the condensing coil partialization"

Cooling - Standard acoustic configuration (ST)

SIZE		Entering external exchanger air temperature (°C)											
		25		30		35		40		45		50	
		kWf	kWe	kWf	kWe	kWf	kWe	kWf	kWe	kWf	kWe	kWf	kWe
120.1	5	215	47,6	203	52,6	191	57,9	181	64,1	170	70,8	158	78,0
	6	222	48,1	210	53,1	198	58,5	187	64,8	176	71,5	164	78,6
	7	229	48,6	217	53,6	204	59,1	194	65,4	182	72,1	170	79,3
	10	252	50,5	239	55,7	226	61,3	214	67,8	202	74,8	189	82,1
	15	290	53,5	275	59,1	260	64,9	248	71,7	234	79,0	220	86,6
	18	312	55,4	297	61,1	281	67,1	268	74,1	254	81,5	239	89,3
160.1	5	271	65,3	256	71,4	241	77,8	228	85,3	214	93,3	195	101
	6	279	66,2	264	72,3	249	78,7	235	86,3	221	94,3	202	102
	7	288	67,1	272	73,2	256	79,6	242	87,2	228	95,2	210	103
	10	315	70,1	298	76,4	281	82,9	266	90,6	251	98,8	232	107
	15	360	75,3	342	81,7	322	88,4	306	96,4	289	105	270	114
	18	386	78,2	367	84,8	346	91,6	329	99,7	310	108	292	117
200.1	5	375	88,2	357	96,2	338	105	322	115	304	126	284	137
	6	387	89,3	369	97,4	349	106	332	116	314	127	294	138
	7	399	90,5	380	98,6	360	107	343	117	324	128	304	140
	10	438	94,6	417	103	395	112	377	122	357	133	335	145
	15	502	101	478	110	454	119	433	130	410	142	386	154
	18	539	106	514	114	488	124	465	135	441	147	417	159
240.1	5	439	110	418	120	396	130	373	142	349	155	329	166
	6	455	111	433	121	408	132	387	144	362	157	341	168
	7	470	113	446	123	420	134	398	146	375	159	353	170
	10	513	119	487	129	460	140	436	153	411	166	387	178
	15	585	129	556	139	525	151	499	164	471	178	443	192
	18	626	134	595	145	563	157	535	170	506	184	475	200
290.1	5	529	130	503	140	481	152	449	162	421	174	386	186
	6	547	132	521	142	496	154	466	165	437	177	402	189
	7	566	135	540	145	511	156	483	168	453	180	418	192
	10	623	142	592	152	559	163	531	176	501	189	465	201
	15	710	153	675	163	640	174	609	187	576	202	541	217
	18	761	158	724	170	686	180	654	195	619	209	584	224
250.2	5	433	97,7	412	109	395	121	370	133	343	146	317	160
	6	450	99,1	428	110	409	122	383	134	357	148	331	162
	7	466	101	444	112	423	123	397	136	371	150	344	164
	10	516	105	492	116	466	128	441	142	414	156	385	170
	15	599	111	569	123	537	135	511	150	482	165	453	181
	18	648	114	614	127	579	139	551	154	522	170	491	186
280.2	5	499	116	476	128	453	142	424	155	396	169	365	184
	6	517	118	493	130	468	143	440	157	411	171	380	186
	7	536	119	510	132	483	145	456	159	427	174	395	189
	10	591	125	561	137	530	150	502	165	474	181	440	197
	15	677	133	643	146	608	159	578	175	546	191	512	209
	18	727	138	691	151	653	164	621	180	588	197	553	215
320.2	5	558	136	533	150	507	165	475	180	442	195	407	211
	6	578	138	550	152	524	167	491	181	459	198	424	214
	7	599	140	570	154	540	169	509	184	476	200	440	217
	10	661	148	628	161	592	175	561	192	527	209	490	226
	15	758	158	719	172	679	187	645	204	609	222	572	241
	18	814	164	772	178	730	193	693	210	655	229	616	248
360.2	5	651	159	624	176	595	194	558	211	519	230	483	249
	6	674	162	643	178	613	196	575	214	538	233	502	253
	7	696	164	664	181	631	198	595	217	558	237	520	256
	10	764	172	729	189	690	206	655	226	615	247	575	268
	15	872	183	831	201	787	219	748	240	708	262	667	285
	18	933	190	889	208	843	226	803	248	760	271	717	294

Performances

Cooling - Standard acoustic configuration (ST)

SIZE	To (°C)	Entering external exchanger air temperature (°C)											
		25		30		35		40		45		50	
		kWf	kWe	kWf	kWe	kWf	kWe	kWf	kWe	kWf	kWe	kWf	kWe
400.2	5	734	182	702	201	668	221	626	240	583	260	527	278
	6	761	186	725	204	689	224	647	243	606	264	549	283
	7	788	189	751	208	711	227	671	247	628	268	572	287
	10	869	200	826	219	780	237	739	259	695	281	639	302
	15	996	216	946	235	893	254	848	277	801	301	749	325
	18	1069	225	1015	244	959	264	912	287	861	311	811	337
440.2	5	814	202	779	221	743	241	697	260	652	279	610	300
	6	844	206	805	224	766	244	722	262	678	283	634	304
	7	873	209	834	227	790	246	748	266	703	288	658	309
	10	961	220	915	238	866	256	823	278	778	301	730	322
	15	1098	237	1046	256	991	275	945	298	896	322	846	345
	18	1177	246	1122	265	1064	284	1016	308	964	333	912	358
480.2	5	908	228	868	252	827	277	775	300	721	324	690	354
	6	942	233	897	256	854	281	801	304	749	330	715	360
	7	976	238	929	260	881	285	830	309	778	335	740	366
	10	1077	252	1025	275	968	298	918	326	862	353	815	383
	15	1238	275	1176	299	1112	323	1056	352	995	382	940	412
	18	1330	287	1264	312	1196	337	1136	366	1071	396	1006	428
540.2	5	1016	250	968	273	913	295	863	320	815	346	761	374
	6	1046	255	996	277	940	299	889	325	840	352	784	379
	7	1075	260	1023	281	966	303	915	329	864	358	808	385
	10	1169	271	1113	293	1051	316	997	342	943	371	883	401
	15	1326	292	1261	314	1193	337	1134	365	1074	395	1009	426
	18	1416	303	1347	326	1275	350	1214	378	1149	408	1081	440
580.2	5	1086	271	1040	294	992	319	932	341	872	366	809	392
	6	1126	276	1074	298	1024	322	964	345	906	372	841	398
	7	1166	281	1113	303	1056	326	999	351	939	377	874	405
	10	1286	296	1224	318	1159	340	1102	367	1041	395	971	423
	15	1473	318	1402	340	1329	363	1266	391	1200	422	1130	455
	18	1580	330	1505	352	1427	376	1361	405	1291	436	1218	469

kWf = Cooling capacity in kW

kWe = Compressor power input in kW

To (°C) = Internal exchanger outlet water temperature (evaporator)

Performances in function of the inlet/outlet water temperature differential = 5°C

Cooling - Compressor soundproofing (SC)

		Entering external exchanger air temperature (°C)									
SIZE	To (°C)	25		30		35		40		45	
		kWf	kWe	kWf	kWe	kWf	kWe	kWf	kWe	kWf	kWe
120.1	5	215	47,6	203	52,6	191	57,9	181	64,1	170	70,8
	6	222	48,1	210	53,1	198	58,5	187	64,8	176	71,5
	7	229	48,6	217	53,6	204	59,1	194	65,4	182	72,1
	10	252	50,5	239	55,7	226	61,3	214	67,8	202	74,8
	15	290	53,5	275	59,1	260	64,9	248	71,7	234	79,0
	18	312	55,4	297	61,1	281	67,1	268	74,1	254	81,5
160.1	5	271	65,3	256	71,4	241	77,8	228	85,3	214	93,3
	6	279	66,2	264	72,3	249	78,7	235	86,3	221	94,3
	7	288	67,1	272	73,2	256	79,6	242	87,2	228	95,2
	10	315	70,1	298	76,4	281	82,9	266	90,6	251	98,8
	15	360	75,3	342	81,7	322	88,4	306	96,4	289	105
	18	386	78,2	367	84,8	346	91,6	329	99,7	310	108
200.1	5	375	88,2	357	96,2	338	105	322	115	304	126
	6	387	89,3	369	97,4	349	106	332	116	314	127
	7	399	90,5	380	98,6	360	107	343	117	324	128
	10	438	94,6	417	103	395	112	377	122	357	133
	15	502	101	478	110	454	119	433	130	410	142
	18	539	106	514	114	488	124	465	135	441	147
240.1	5	439	110	418	120	396	130	373	142	349	155
	6	455	111	433	121	408	132	387	144	362	157
	7	470	113	446	123	420	134	398	146	375	159
	10	513	119	487	129	460	140	436	153	411	166
	15	585	129	556	139	525	151	499	164	471	178
	18	626	134	595	145	563	157	535	170	506	184
290.1	5	529	130	503	140	481	152	449	162	421	174
	6	547	132	521	142	496	154	466	165	437	177
	7	566	135	540	145	511	156	483	168	453	180
	10	623	142	592	152	559	163	531	176	501	189
	15	710	153	675	163	640	174	609	187	576	202
	18	761	158	724	170	686	180	654	195	619	209
250.2	5	433	97,7	412	109	395	121	370	133	343	146
	6	450	99,1	428	110	409	122	383	134	357	148
	7	466	101	444	112	423	123	397	136	371	150
	10	516	105	492	116	466	128	441	142	414	156
	15	599	111	569	123	537	135	511	150	482	165
	18	648	114	614	127	579	139	551	154	522	170
280.2	5	499	116	476	128	453	142	424	155	396	169
	6	517	118	493	130	468	143	440	157	411	171
	7	536	119	510	132	483	145	456	159	427	174
	10	591	125	561	137	530	150	502	165	474	181
	15	677	133	643	146	608	159	578	175	546	191
	18	727	138	691	151	653	164	621	180	588	197
320.2	5	558	136	533	150	507	165	475	180	442	195
	6	578	138	550	152	524	167	491	181	459	198
	7	599	140	570	154	540	169	509	184	476	200
	10	661	148	628	161	592	175	561	192	527	209
	15	758	158	719	172	679	187	645	204	609	222
	18	814	164	772	178	730	193	693	210	655	229
360.2	5	651	159	624	176	595	194	558	211	519	230
	6	674	162	643	178	613	196	575	214	538	233
	7	696	164	664	181	631	198	595	217	558	237
	10	764	172	729	189	690	206	655	226	615	247
	15	872	183	831	201	787	219	748	240	708	262
	18	933	190	889	208	843	226	803	248	760	271

Performances

Cooling - Compressor soundproofing (SC)

SIZE	To (°C)	Entering external exchanger air temperature (°C)									
		25		30		35		40		45	
		kWf	kWe	kWf	kWe	kWf	kWe	kWf	kWe	kWf	kWe
400.2	5	734	182	702	201	668	221	626	240	583	260
	6	761	186	725	204	689	224	647	243	606	264
	7	788	189	751	208	711	227	671	247	628	268
	10	869	200	826	219	780	237	739	259	695	281
	15	996	216	946	235	893	254	848	277	801	301
	18	1069	225	1015	244	959	264	912	287	861	311
440.2	5	814	202	779	221	743	241	697	260	652	279
	6	844	206	805	224	766	244	722	262	678	283
	7	873	209	834	227	790	246	748	266	703	288
	10	961	220	915	238	866	256	823	278	778	301
	15	1098	237	1046	256	991	275	945	298	896	322
	18	1177	246	1122	265	1064	284	1016	308	964	333
480.2	5	908	228	868	252	827	277	775	300	721	324
	6	942	233	897	256	854	281	801	304	749	330
	7	976	238	929	260	881	285	830	309	778	335
	10	1077	252	1025	275	968	298	918	326	862	353
	15	1238	275	1176	299	1112	323	1056	352	995	382
	18	1330	287	1264	312	1196	337	1136	366	1071	396
540.2	5	1016	250	968	273	913	295	863	320	815	346
	6	1046	255	996	277	940	299	889	325	840	352
	7	1075	260	1023	281	966	303	915	329	864	358
	10	1169	271	1113	293	1051	316	997	342	943	371
	15	1326	292	1261	314	1193	337	1134	365	1074	395
	18	1416	303	1347	326	1275	350	1214	378	1149	408
580.2	5	1086	271	1040	294	992	319	932	341	872	366
	6	1126	276	1074	298	1024	322	964	345	906	372
	7	1166	281	1113	303	1056	326	999	351	939	377
	10	1286	296	1224	318	1159	340	1102	367	1041	395
	15	1473	318	1402	340	1329	363	1266	391	1200	422
	18	1580	330	1505	352	1427	376	1361	405	1291	436

kWf = Cooling capacity in kW

kWe = Compressor power input in kW

To (°C) = Internal exchanger outlet water temperature (evaporator)

Performances in function of the inlet/outlet water temperature differential = 5°C

Cooling - Super-silenced acoustic configuration EN

SIZE		Entering external exchanger air temperature (°C)									
		25		30		35		40		45	
		kWf	kWe	kWf	kWe	kWf	kWe	kWf	kWe	kWf	kWe
120.1	5	215	47,6	203	52,6	191	57,9	181	64,1	170	70,8
	6	222	48,1	210	53,1	198	58,5	187	64,8	176	71,5
	7	229	48,6	217	53,6	204	59,1	194	65,4	182	72,1
	10	252	50,5	239	55,7	226	61,3	214	67,8	202	74,8
	15	290	53,5	275	59,1	260	64,9	248	71,7	234	79,0
	18	312	55,4	297	61,1	281	67,1	268	74,1	254	81,5
160.1	5	271	65,3	256	71,4	241	77,8	228	85,3	214	93,3
	6	279	66,2	264	72,3	249	78,7	235	86,3	221	94,3
	7	288	67,1	272	73,2	256	79,6	242	87,2	228	95,2
	10	315	70,1	298	76,4	281	82,9	266	90,6	251	98,8
	15	360	75,3	342	81,7	322	88,4	306	96,4	289	105
	18	386	78,2	367	84,8	346	91,6	329	99,7	310	108
200.1	5	375	88,2	357	96,2	338	105	322	115	304	126
	6	387	89,3	369	97,4	349	106	332	116	314	127
	7	399	90,5	380	98,6	360	107	343	117	324	128
	10	438	94,6	417	103	395	112	377	122	357	133
	15	502	101	478	110	454	119	433	130	410	142
	18	539	106	514	114	488	124	465	135	441	147
240.1	5	439	110	418	120	396	130	373	142	349	155
	6	455	111	433	121	408	132	387	144	362	157
	7	470	113	446	123	420	134	398	146	375	159
	10	513	119	487	129	460	140	436	153	411	166
	15	585	129	556	139	525	151	499	164	471	178
	18	626	134	595	145	563	157	535	170	506	184
290.1	5	510	121	488	131	465	142	437	152	408	163
	6	527	122	503	132	480	143	451	154	423	164
	7	545	124	520	134	495	145	467	155	439	167
	10	601	131	574	141	543	151	516	163	486	175
	15	689	141	656	151	622	161	592	174	561	187
	18	739	146	704	156	668	167	637	180	604	194
250.2	5	433	97,7	412	109	395	121	370	133	343	146
	6	450	99,1	428	110	409	122	383	134	357	148
	7	466	101	444	112	423	123	397	136	371	150
	10	516	105	492	116	466	128	441	142	414	156
	15	599	111	569	123	537	135	511	150	482	165
	18	648	114	614	127	579	139	551	154	522	170
280.2	5	499	116	476	128	453	142	424	155	396	169
	6	517	118	493	130	468	143	440	157	411	171
	7	536	119	510	132	483	145	456	159	427	174
	10	591	125	561	137	530	150	502	165	474	181
	15	677	133	643	146	608	159	578	175	546	191
	18	727	138	691	151	653	164	621	180	588	197
320.2	5	558	136	533	150	507	165	475	180	442	195
	6	578	138	550	152	524	167	491	181	459	198
	7	599	140	570	154	540	169	509	184	476	200
	10	661	148	628	161	592	175	561	192	527	209
	15	758	158	719	172	679	187	645	204	609	222
	18	814	164	772	178	730	193	693	210	655	229
360.2	5	651	159	624	176	595	194	558	211	519	230
	6	674	162	643	178	613	196	575	214	538	233
	7	696	164	664	181	631	198	595	217	558	237
	10	764	172	729	189	690	206	655	226	615	247
	15	872	183	831	201	787	219	748	240	708	262
	18	933	190	889	208	843	226	803	248	760	271

Performances

Cooling - Super-silenced acoustic configuration EN

SIZE	To (°C)	Entering external exchanger air temperature (°C)									
		25		30		35		40		45	
		kWf	kWe	kWf	kWe	kWf	kWe	kWf	kWe	kWf	kWe
400.2	5	734	182	702	201	668	221	626	240	583	260
	6	761	186	725	204	689	224	647	243	606	264
	7	788	189	751	208	711	227	671	247	628	268
	10	869	200	826	219	780	237	739	259	695	281
	15	996	216	946	235	893	254	848	277	801	301
	18	1069	225	1015	244	959	264	912	287	861	311
440.2	5	814	202	779	221	743	241	697	260	652	279
	6	844	206	805	224	766	244	722	262	678	283
	7	873	209	834	227	790	246	748	266	703	288
	10	961	220	915	238	866	256	823	278	778	301
	15	1098	237	1046	256	991	275	945	298	896	322
	18	1177	246	1122	265	1064	284	1016	308	964	333
480.2	5	908	228	868	252	827	277	775	300	721	324
	6	942	233	897	256	854	281	801	304	749	330
	7	976	238	929	260	881	285	830	309	778	335
	10	1077	252	1025	275	968	298	918	326	862	353
	15	1238	275	1176	299	1112	323	1056	352	995	382
	18	1330	287	1264	312	1196	337	1136	366	1071	396
540.2	5	1016	250	968	273	913	295	863	320	815	346
	6	1046	255	996	277	940	299	889	325	840	352
	7	1075	260	1023	281	966	303	915	329	864	358
	10	1169	271	1113	293	1051	316	997	342	943	371
	15	1326	292	1261	314	1193	337	1134	365	1074	395
	18	1416	303	1347	326	1275	350	1214	378	1149	408
580.2	5	1086	271	1040	294	992	319	932	341	872	366
	6	1126	276	1074	298	1024	322	964	345	906	372
	7	1166	281	1113	303	1056	326	999	351	939	377
	10	1286	296	1224	318	1159	340	1102	367	1041	395
	15	1473	318	1402	340	1329	363	1266	391	1200	422
	18	1580	330	1505	352	1427	376	1361	405	1291	436

kWf = Cooling capacity in kW

kWe = Compressor power input in kW

To (°C) = Internal exchanger outlet water temperature (evaporator)

Performances in function of the inlet/outlet water temperature differential = 5°C

Internal exchanger (evaporator) pressure drop - Size 120.1 ÷ 290.1

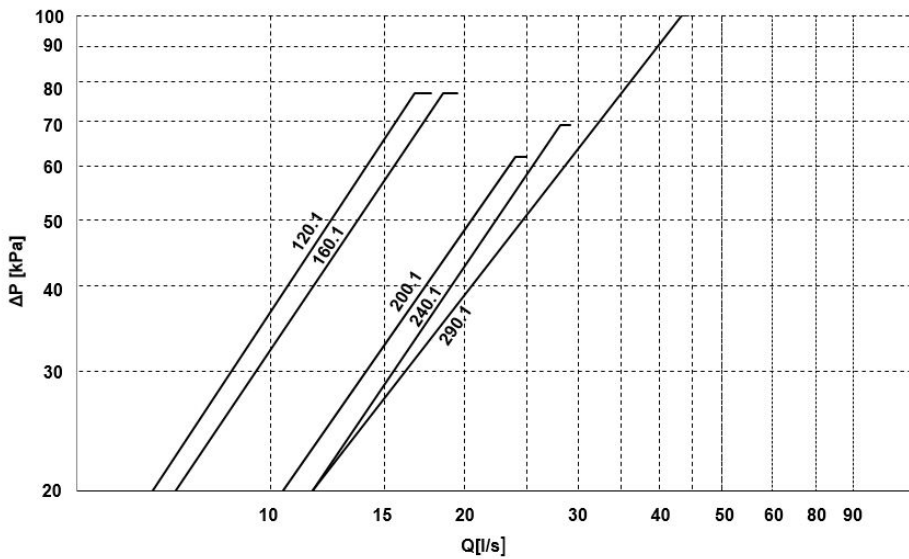

The pressure drops are calculated considering a water temperature of 7°C

Q = Water flow-rate[l/s]
DP = Water side pressure drops (kPa)

The water flow-rate must be calculated with the following formula

$$Q [l/s] = kWf / (4,186 \times DT)$$

kWf = Cooling capacity in kW
DT = Temperature difference between inlet / outlet water

Admissible water flow-rates

Minimum (Qmin) and maximum (Qmax) admissible water flow for the unit to operate correctly.

SIZE		120.1	160.1	200.1	240.1	290.1
Qmin	[l/s]	6,6	7,1	10,5	11,6	11,6
Qmax	[l/s]	16,7	18,5	23,9	28,1	43,4

Internal exchanger (evaporator) pressure drop - Size 250.2 ÷ 580.2

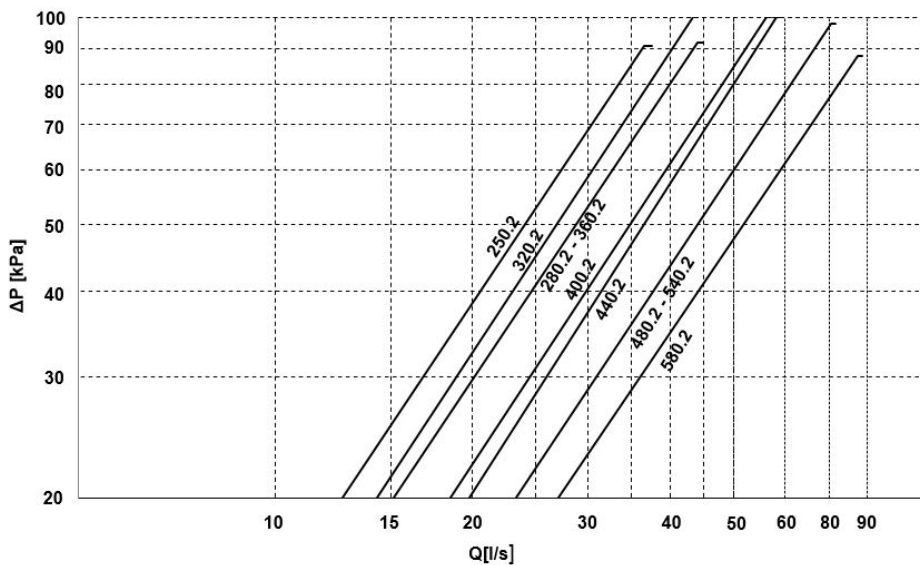

The pressure drops are calculated considering a water temperature of 7°C

Q = Water flow-rate[l/s]
DP = Water side pressure drops (kPa)

The water flow-rate must be calculated with the following formula

$$Q [l/s] = kWf / (4,186 \times DT)$$

kWf = Cooling capacity in kW
DT = Temperature difference between inlet / outlet water

Admissible water flow-rates

Minimum (Qmin) and maximum (Qmax) admissible water flow for the unit to operate correctly.

SIZE		250.2	280.2	320.2	360.2	400.2	440.2	480.2	540.2	580.2
Qmin	[l/s]	12,7	15,2	14,3	15,2	18,5	19,8	23,3	23,3	27,0
Qmax	[l/s]	36,6	44,1	43,4	44,1	56,2	58,3	70,5	70,5	77,6

Performances

Cooling at part load - Standard acoustic configuration (ST) / Compressor soundproofing (SC)

SIZE	Load	Entering external exchanger air temperature (°C)											
		35°C			30°C			25°C			20°C		
		kWf	kWe_tot	EER	kWf	kWe_tot	EER	kWf	kWe_tot	EER	kWf	kWe_tot	EER
120.1	100	204	63,7	3,2	217	58,2	3,73	229	53,2	4,30	240	48,4	4,96
	75	153	38,8	3,94	163	35,7	4,56	172	32,6	5,26	180	29,9	6,01
	50	102	25,0	4,08	108	22,4	4,84	114	20,1	5,70	120	18,2	6,61
	25	60	14,6	4,11	65	12,5	5,2	70	10,7	6,54	74	9,3	7,96
	Minimum	-	-	-	-	-	-	-	-	-	-	-	-
160.1	100	256	84,2	3,04	272	77,8	3,5	288	71,7	4,02	303	65,9	4,60
	75	192	53,3	3,6	204	49,2	4,15	216	45,6	4,73	227	42,3	5,38
	50	128	33,7	3,80	136	30,4	4,48	144	27,7	5,20	152	25,4	5,96
	25	75	18,9	3,97	81	16,3	4,97	87	14,1	6,17	92	12,4	7,42
	Minimum	-	-	-	-	-	-	-	-	-	-	-	-
200.1	100	360	114	3,16	380	105	3,61	399	97,3	4,10	418	89,7	4,66
	75	270	73,4	3,68	285	67,7	4,21	299	62,7	4,77	313	58,4	5,37
	50	180	45,1	3,99	190	40,8	4,66	200	37,2	5,36	209	34,4	6,07
	25	125	29,3	4,27	134	26,2	5,11	143	23,7	6,03	150	21,7	6,91
	Minimum	-	-	-	-	-	-	-	-	-	-	-	-
240.1	100	420	140	2,99	446	130	3,43	470	120,0	3,92	492	110	4,46
	75	315	88,1	3,58	334	82,1	4,07	353	76,4	4,62	369	70,6	5,22
	50	210	53,2	3,94	223	49	4,55	235	45,1	5,21	246	41,8	5,88
	25	125	29,3	4,27	134	26,2	5,11	143	23,7	6,03	151	21,7	6,96
	Minimum	-	-	-	-	-	-	-	-	-	-	-	-
290.1	100	511	165	3,1	540	154	3,51	566	144,0	3,94	592	134	4,42
	75	383	98	3,91	405	91,8	4,41	424	85,8	4,95	444	80,6	5,51
	50	256	58,0	4,41	270	53,3	5,07	283	48,9	5,78	296	45,7	6,48
	25	148	30,5	4,85	159	26,8	5,93	169	23,8	7,10	177	21,5	8,23
	Minimum	-	-	-	-	-	-	-	-	-	-	-	-
250.2	100	423	132	3,19	444	121	3,68	466	110,0	4,25	487	99,2	4,91
	75	317	86,8	3,66	333	78,5	4,24	350	71,6	4,88	365	65,4	5,59
	50	211	55,4	3,82	222	49	4,53	233	44,0	5,30	243	39,8	6,12
	25	106	27,2	3,89	111	22,6	4,91	116	19,1	6,09	122	16,5	7,37
	Minimum	59	16	3,69	63	13,9	4,53	67	12,0	5,58	71	10,6	6,7
280.2	100	483	154	3,14	510	141	3,62	536	128,0	4,17	560	117	4,79
	75	362	98,3	3,69	382	90	4,25	402	82,8	4,86	420	75,8	5,54
	50	241	62,2	3,88	255	55,8	4,57	268	50,3	5,33	280	45,5	6,15
	25	121	30,4	3,98	128	25,4	5,02	134	21,6	6,19	140	18,5	7,55
	Minimum	68	18,1	3,76	74	15,7	4,71	79	13,7	5,77	84	12	7,00
320.2	100	540	178	3,04	570	163	3,49	599	150,0	4,01	627	136	4,59
	75	405	113	3,58	428	104	4,11	449	95,6	4,70	470	88,1	5,34
	50	270	71,2	3,79	285	63,9	4,46	300	57,9	5,17	313	52,8	5,93
	25	135	34	3,97	142	28,7	4,97	150	24,5	6,11	157	21,3	7,36
	Minimum	77	20,4	3,77	83	17,7	4,69	89	15,5	5,74	94	13,7	6,86
360.2	100	631	210	3,01	664	192	3,45	696	176,0	3,96	726	160	4,54
	75	473	129	3,66	498	119	4,19	522	109,0	4,78	544	100	5,42
	50	316	79,9	3,95	332	72,2	4,6	348	65,6	5,30	363	60,2	6,03
	25	158	38,2	4,13	166	32,9	5,05	174	28,7	6,06	181	25,6	7,08
	Minimum	90	22,9	3,93	97	20,4	4,75	104	18,3	5,68	110	16,6	6,63
400.2	100	711	238	2,98	751	219	3,43	788	201,0	3,93	824	183	4,50
	75	533	146	3,65	563	135	4,17	591	124,0	4,75	618	115	5,38
	50	356	89,8	3,96	376	81,7	4,6	394	74,5	5,29	412	68,6	6,01
	25	178	42,3	4,2	188	36,6	5,13	197	32,2	6,12	206	28,8	7,16
	Minimum	103	25,6	4,02	111	22,8	4,87	118	20,4	5,78	125	18,5	6,76

Load = % of cooling capacity compared to the value at full load

kWf = cooling capacity in kW

kWe_tot = unit total power input in kW

Internal exchanger water temperature = leaving 7°C / entering 12°C / variable flow-rate with external exchanger air temperature

Cooling at part load - Standard acoustic configuration (ST) / Compressor soundproofing (SC)

SIZE	Load	Entering external exchanger air temperature (°C)											
		35°C			30°C			25°C			20°C		
		kWf	kWe_tot	EER	kWf	kWe_tot	EER	kWf	kWe_tot	EER	kWf	kWe_tot	EER
440.2	100	790	260	3,04	834	241	3,47	873	223,0	3,92	912	206	4,43
	75	592	157	3,77	625	146	4,27	655	136,0	4,82	684	127	5,40
	50	395	94,6	4,18	417	86	4,85	436	78,5	5,56	456	72,6	6,28
	25	197	43,6	4,53	208	37,5	5,56	218	32,6	6,69	228	28,9	7,88
	Minimum	117	26,9	4,35	125	23,7	5,27	133	21	6,33	139	18,9	7,35
480.2	100	881	298	2,96	929	274	3,39	976	251,0	3,89	1019	230	4,44
	75	661	179	3,68	697	166	4,21	732	153,0	4,78	764	142	5,40
	50	440	109,0	4,05	464	99,4	4,67	488	91,3	5,34	509	84,6	6,02
	25	220	50,9	4,33	232	44,8	5,19	244	39,9	6,12	255	36,4	6,99
	Minimum	127	30,7	4,14	137	27,6	4,96	146	25,1	5,82	153	23,2	6,59
540.2	100	966	318	3,03	1023	297	3,45	1075	275,0	3,91	1124	254	4,43
	75	724	190	3,82	767	177	4,33	806	166,0	4,86	843	155	5,44
	50	483	113,0	4,27	512	104	4,93	538	95,8	5,61	562	89,2	6,30
	25	241	52	4,64	256	45,6	5,61	269	40,6	6,63	281	36,7	7,65
	Minimum	143	32,3	4,43	153	28,8	5,31	163	26	6,27	171	23,8	7,18
580.2	100	1056	344	3,07	1113	321	3,47	1166	299,0	3,90	1217	278	4,37
	75	792	205	3,87	835	191	4,36	874	179,0	4,89	913	168	5,43
	50	528	120,0	4,39	557	110	5,05	583	101,0	5,75	608	94,5	6,44
	25	264	54,6	4,83	278	47,4	5,87	292	41,7	7,00	304	37,6	8,10
	Minimum	157	34,1	4,6	168	30,2	5,56	177	27	6,56	186	24,6	7,56

Load = % of cooling capacity compared to the value at full load

kWf = cooling capacity in kW

kWe_tot = unit total power input in kW

Internal exchanger water temperature = leaving 7°C / entering 12°C / variable flow-rate with external exchanger air temperature

Performances

Cooling at part load - Acoustic configuration Super-silenced (EN)

GRANDEZZE	Load	Temperatura aria entrante allo scambiatore esterno (°C)											
		35°C			30°C			25°C			20°C		
		kWf	kWe_tot	EER	kWf	kWe_tot	EER	kWf	kWe_tot	EER	kWf	kWe_tot	EER
120.1	100	204	63,7	3,2	217	58,2	3,73	229	53,2	4,30	240	48,4	4,96
	75	153	38,8	3,94	163	35,7	4,56	172	32,6	5,26	180	29,9	6,01
	50	102	25,1	4,06	108	22,5	4,82	114	20,2	5,68	120	18,3	6,57
	25	60	14,9	4,03	65	12,8	5,08	70	11,0	6,36	74	9,6	7,71
	Minimum	-	-	-	-	-	-	-	-	-	-	-	-
160.1	100	256	84,2	3,04	272	77,8	3,5	288	71,7	4,02	303	65,9	4,60
	75	192	53,3	3,6	204	49,2	4,15	216	45,6	4,73	227	42,3	5,38
	50	128	33,8	3,79	136	30,5	4,47	144	27,8	5,18	152	25,5	5,94
	25	75	19,2	3,91	81	16,6	4,88	87	14,4	6,04	92	12,7	7,24
	Minimum	-	-	-	-	-	-	-	-	-	-	-	-
200.1	100	360	114	3,16	380	105	3,61	399	97,3	4,10	418	89,7	4,66
	75	270	73,4	3,68	285	67,7	4,21	299	62,7	4,77	313	58,4	5,37
	50	180	45,3	3,98	190	40,9	4,64	200	37,4	5,34	209	34,6	6,05
	25	125	29,6	4,22	134	26,5	5,06	143	24,0	5,96	150	22	6,82
	Minimum	-	-	-	-	-	-	-	-	-	-	-	-
240.1	100	420	140	2,99	446	130	3,43	470	120,0	3,92	492	110	4,46
	75	315	88,1	3,58	334	82,1	4,07	353	76,4	4,62	369	70,6	5,22
	50	210	53,3	3,94	223	49,1	4,54	235	45,2	5,20	246	41,9	5,87
	25	125	29,6	4,22	134	26,5	5,06	143	24,0	5,96	151	22	6,86
	Minimum	-	-	-	-	-	-	-	-	-	-	-	-
290.1	100	495	154	3,21	520	143	3,63	545	133,0	4,09	569	124	4,57
	75	371	94	3,95	390	87,3	4,47	409	81,5	5,02	427	76,4	5,59
	50	247	56,0	4,42	260	51	5,1	272	46,7	5,84	284	43,4	6,55
	25	148	30,8	4,81	159	27,1	5,87	169	24,1	7,01	177	21,8	8,12
	Minimum	-	-	-	-	-	-	-	-	-	-	-	-
250.2	100	423	132	3,19	444	121	3,68	466	110,0	4,25	487	99,2	4,91
	75	317	86,8	3,66	333	78,5	4,24	350	71,6	4,88	365	65,4	5,59
	50	211	55,4	3,82	222	49,1	4,53	233	44,0	5,29	243	39,8	6,11
	25	106	27,4	3,86	111	22,8	4,86	116	19,4	6,02	122	16,8	7,27
	Minimum	59	16,3	3,62	63	14,2	4,44	67	12,3	5,45	71	10,9	6,51
280.2	100	483	154	3,14	510	141	3,62	536	128,0	4,17	560	117	4,79
	75	362	98,3	3,69	382	90	4,25	402	82,8	4,86	420	75,8	5,54
	50	241	62,3	3,88	255	55,8	4,57	268	50,4	5,32	280	45,5	6,15
	25	121	30,6	3,95	128	25,6	4,98	134	21,9	6,13	140	18,8	7,46
	Minimum	68	18,4	3,7	74	16	4,63	79	14	5,64	84	12,3	6,83
320.2	100	540	178	3,03	570	163	3,49	599	150,0	4,01	627	136	4,59
	75	405	113	3,58	428	104	4,11	449	95,6	4,70	470	88,1	5,34
	50	270	71,3	3,79	285	64	4,45	300	58,0	5,17	313	52,9	5,93
	25	135	34,3	3,94	142	28,9	4,93	150	24,7	6,05	157	21,5	7,28
	Minimum	77	20,7	3,72	83	18	4,61	89	15,8	5,63	94	14	6,71
360.2	100	631	210	3,01	664	192	3,45	696	176,0	3,96	726	160	4,54
	75	473	129	3,66	498	119	4,19	522	109,0	4,78	544	100	5,42
	50	316	79,9	3,95	332	72,2	4,6	348	65,7	5,30	363	60,2	6,03
	25	158	38,4	4,11	166	33,1	5,02	174	29,0	6,01	181	25,9	7,02
	Minimum	90	23,2	3,88	97	20,7	4,69	104	18,6	5,59	110	16,9	6,51
400.2	100	711	238	2,98	751	219	3,43	788	201,0	3,93	824	183	4,50
	75	533	146	3,65	563	135	4,17	591	124,0	4,75	618	115	5,38
	50	356	89,8	3,96	376	81,7	4,59	394	74,6	5,28	412	68,6	6,00
	25	178	42,5	4,18	188	36,9	5,09	197	32,4	6,08	206	29	7,11
	Minimum	103	25,9	3,98	111	23,1	4,81	118	20,7	5,7	125	18,8	6,65

Load = % of cooling capacity compared to the value at full load

kWf = cooling capacity in kW

kWe_tot = unit total power input in kW

Internal exchanger water temperature = leaving 7°C / entering 12°C / variable flow-rate with external exchanger air temperature

Cooling at part load - Acoustic configuration Super-silenced (EN)

GRANDEZZE	Load	Temperatura aria entrante allo scambiatore esterno (°C)											
		35°C			30°C			25°C			20°C		
		kWf	kWe_tot	EER	kWf	kWe_tot	EER	kWf	kWe_tot	EER	kWf	kWe_tot	EER
480.2	100	881	298	2,96	929	274	3,39	976	251,0	3,89	1019	230	4,44
	75	661	179	3,68	697	166	4,21	732	153,0	4,78	764	142	5,40
	50	440	109,0	4,05	464	99,5	4,67	488	91,4	5,34	509	84,6	6,02
	25	220	51,1	4,31	232	45	5,16	244	40,1	6,08	255	36,7	6,95
	Minimum	127	31	4,1	137	27,9	4,91	146	25,4	5,75	153	23,5	6,51
540.2	100	966	318	3,03	1023	297	3,45	1075	275,0	3,91	1124	254	4,43
	75	724	190	3,82	767	177	4,33	806	166,0	4,86	843	155	5,44
	50	483	113,0	4,27	512	104	4,93	538	95,8	5,61	562	89,3	6,30
	25	241	52,2	4,62	256	45,8	5,58	269	40,8	6,59	281	37	7,60
	Minimum	143	32,6	4,39	153	29,1	5,26	163	26,3	6,2	171	24,1	7,1
580.2	100	1056	344	3,07	1113	321	3,47	1166	299,0	3,90	1217	278	4,37
	75	792	205	3,87	835	191	4,36	874	179,0	4,89	913	168	5,43
	50	528	120,0	4,39	557	110	5,05	583	102,0	5,74	608	94,6	6,43
	25	264	54,8	4,81	278	47,6	5,85	292	41,9	6,96	304	37,8	8,05
	Minimum	157	34,4	4,56	168	30,5	5,51	177	27,3	6,48	186	24,9	7,47

Load = % of cooling capacity compared to the value at full load

kWf = cooling capacity in kW

kWe_tot = unit total power input in kW

Internal exchanger water temperature = leaving 7°C / entering 12°C / variable flow-rate with external exchanger air temperature

Configurations

ST - Standard acoustic configuration

The standard units is supplied with inverter screw compressors without soundproofing casing.

⚠ With the standard acoustic configuration if the hydronic units installed on the unit are selected, they are supplied without casing.

To find out the standard unit sound level, refer to the 'Sound levels' tables.



SC - Acoustic configuration with compressor soundproofing

Configuration used to increase the unit's silent operation by acting on the source of the noise. It consists of suitable steel casings lined with high-density material designed to provide sound insulation. The casings are secured to an aluminium frame and painted on the outside with polyester powder (RAL 9001).

⚠ With the acoustic configuration with compressor soundproofing if the hydronic units installed on the unit are selected, they are supplied without casing.

To assess the quality of the soundproofing benefit, refer to the 'Sound levels' tables.



EN - Super-silenced acoustic configuration

Configuration that further increases the unit's silent operation by acting on the source of the noise. It consists of suitable steel casings lined with high-density material designed to provide sound insulation. The casings are secured to an aluminium frame and painted on the outside with polyester powder (RAL 9001). The unit is also equipped with anti-vibration joints to attenuate vibrations.

⚠ With the super-silenced acoustic configuration, if the hydronic units installed on the unit are selected, they are supplied with casing.

To assess the benefit of the super silenced configuration, refer to the "Sound levels" tables.



PPBM - Microchannel coils protection panels

Microchannel coils protection panels supplied on the manifold side. They guarantee greater protection during transport and from accidental contact with things or people.



Standard unit



Unit with PPBM option

CCME - E-coated microchannel coil

The full aluminium microchannel coil is completely treated by electrolysis so as to create a protective layer of epoxy polymer on the surface, with the following characteristics:

- over 3000 hours of protection against salt spray (ASTM G85 A3 - SWAAT);
- over 2000 hours of protection against UV rays (ASTM G155-05a)
- provide a very high resistance against corrosion.

Categories of atmospheric corrosion

Atmospheric corrosion is divided into six categories of corrosivity level, as shown in table.

Corrosivity	ISO 9223 Category	Corrosion rate for aluminium g/m ²
Very low	C1	trascurabile
Low	C2	$r_{cor} \leq 0.6$
Medium	C3	$0.6 < r_{cor} \leq 2$
High	C4	$2 < r_{cor} \leq 5$
Very high	C5	$5 < r_{cor} \leq 10$
Extreme	CX	$r_{cor} > 10$

Atmospheric Corrosivity category (ISO 9223)	C1, C2	C3 (inland)	C3 (coastal)	C4	C5	CX
Corrosivity	Very low, low	Medium	Medium	High	Very high	Extreme
Typical environments -examples	Indoor, Rural areas	Urban areas	Urban areas	Polluted Urban, industrial, coastal areas	Very high pollution & salt deposition areas	Extreme industrial, coastal areas
CCM - coils (standard)	OK	OK	NR	NR	NR	NR
CCME - E-coated microchannel coil	OK	OK	OK	OK	AP	AP

OK: Recommended;

AP: Acceptable, life may be shorter;

NR: Not recommended

B - Water low temperature (Brine)

Configuration also known as "Brine". Enables an "unfreezable" solution to be cooled (for example, water and ethylene glycol in suitable quantities) up to a temperature of between +4°C and -2°C. It includes:

- suitable exchangers with extra-thick closed-cell insulation
- electronic expansion valve, functional calibration and safety devices suitable for particular uses.

⚠ During the selection phase it is necessary to indicate the required operating type, the unit will be optimised on the basis of this: - Unit with single operating set-point (only at low temperature) - Unit with double operating set-point

⚠ The unit in this configuration has a different operating field, which was reported in the previous pages

⚠ In low temperature operation, some staging steps could not be available

⚠ The glycol concentration must be chosen based on the minimum temperature the water can reach. The presence of glycol influences pressure drops on the water side and the unit's output as indicated in the table reporting the "correction factors for use with glycol".

Correction factor for water low temperature

Evaporator outlet water temperature factor	2	0	-2
Cooling capacity factor	0.860	0.804	0.748
Compressor power input factor	0.945	0.923	0.901

⚠ The correction coefficients must be applied to condition: internal exchanger water (evaporator) = 12 / 7 °C.

Configurations

D - Partial energy recovery

A configuration which enables the production of hot water free-of-charge while operating in the cooling mode, thanks to the partial recovery of condensation heat that would otherwise be rejected to the external heat source. This option is also called 'desuperheater'. It consists of shell and tube heat exchangers, suitable to recover part of the unit heating capacity (equal to the sum of the cooling capacity and the capacity absorbed by the compressors).

The partial recovery device is considered to be operating when it is powered by the water flow which is to be heated. This condition improves the unit performance, since it reduces the condensation temperature: in nominal conditions the cooling capacity increases indicatively by 3.2% and the power input of the compressors is reduced by 3.6%.

When the temperature of the water to be heated is particularly low, it is wise to insert a flow control valve into the system water circuit, in order to maintain the temperature at the recovery output at above 35°C and thus avoid the condensation of the refrigerant into the partial energy recovery device.

⚠ The maximum capacity available from the partial recovery is equal to the 10% of the rejected heating capacity (cooling capacity + compressor power input).

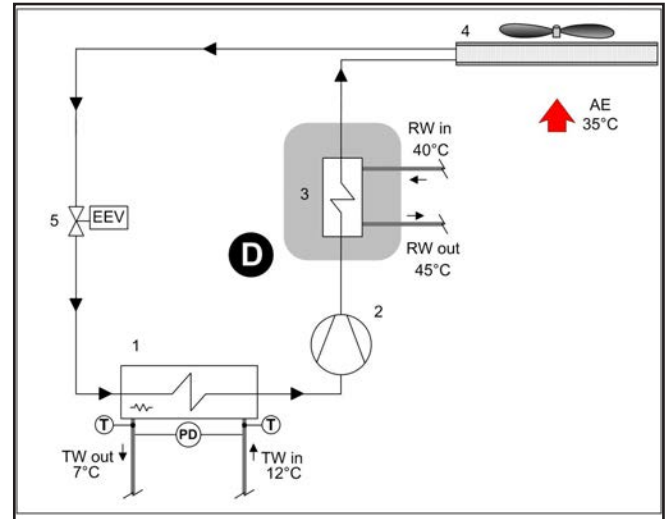

D - Partial recovery device

- 1 - Internal exchanger
- 2 - Compressors
- 3 - Recovery exchanger
- 4 - External exchanger
- 5 - Expansion electronic valve

TW in chilled water inlet
TW out chilled water outlet

RW in - Recovery water inlet
RW out - Recovery water outlet

T - Temperature probe
PD - Differential pressure switch
AE - Outdoor air

Pressure drops of partial energy recovery exchanger

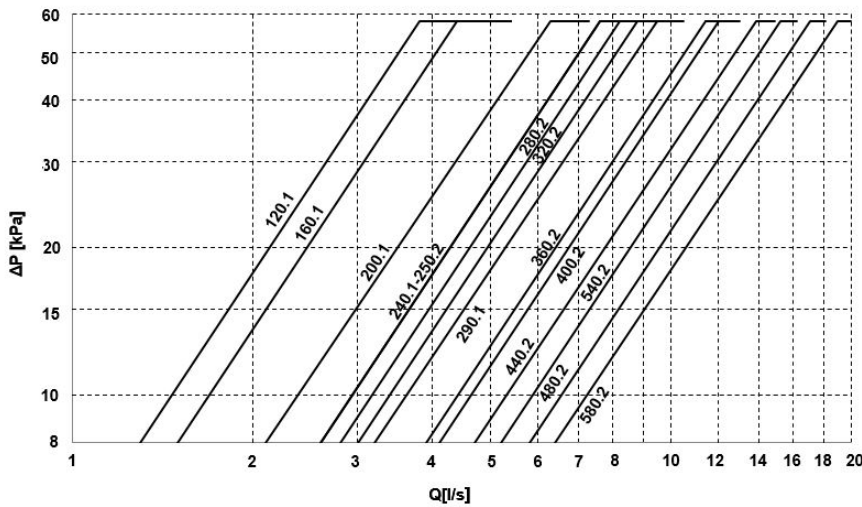

Q = Water flow-rate [l/s]
DP = Water side pressure drops (kPa)

Partial recovery heating capacity

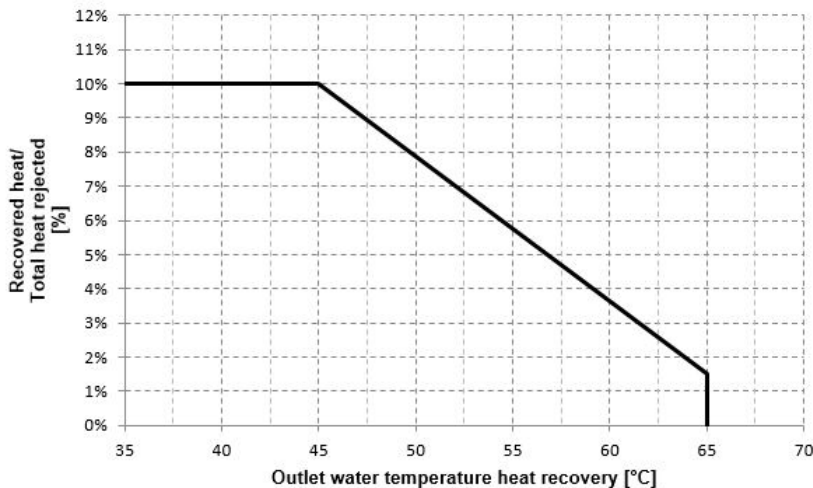

1PM/1PMH - HydroPack with N° 1 pump

Option supplied built-in the unit. Pumping unit made up of N°1 centrifugal electric pump, with the pump body made of cast iron and the impeller made of INOX or cast iron (depending on the models).

Mechanical seal using ceramic, carbon and EPDM elastomer components.

Three-phase electric motor with IP55 degree of protection. Complete with a thermoformed insulating casing, quick connections with insulated casing, non-return valve, safety valve, pressure gauges, system safety pressure switch, stainless steel antifreeze, intake, immersion-type heaters.

All water fittings are Victaulic.

1PM = Hydropack with N° 1 pump

1PMH = Hydropack with N° 1 high static pressure pump

CONNECTION DIAGRAM - GROUP WITH N° 1 PUMP

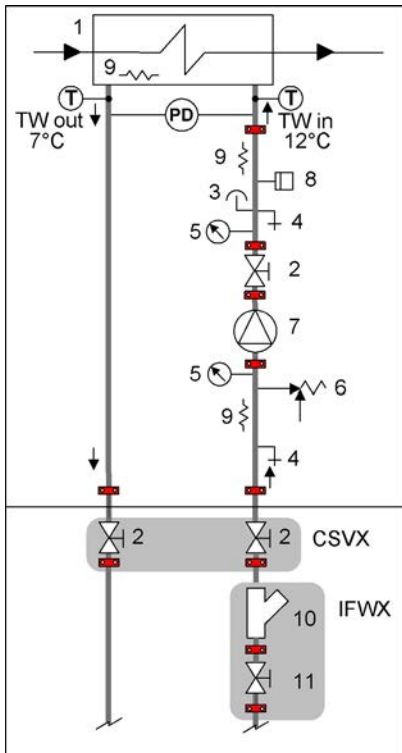

- 1 - Internal exchanger
- 2 - Cutoff valve - (CSVX Couple of manually operated shut-off valves)
- 3 - Purge valve
- 4 - Discharge stop valve
- 5 - Pressure gauge
- 6 - Safety valve (6 Bar)
- 7 - Packaged electric pump with high efficiency impeller
- 8 - System load safety pressure switch (it avoids the pump operation if water is not present)
- 9 - Antifreeze heater
- 10 - Steel mesh strainer water side (IFWX)
- 11 - Cutoff valve with quick joints

T - Temperature probe
PD - Differential pressure switch

TW in chilled water inlet
TW out chilled water outlet

The grey area indicates further optional components..

⚠ Provide hydraulic interceptions outside the unit ('CSVX - Couple of manually operated shut-off valves' option) to facilitate any possible extraordinary maintenance interventions..

⚠ The head and absorption graphs of the hydronic assembly refer to operation with pure water. In the presence of a mixture of water and glycol, please contact Clivet office to check the correct operating point of the hydronic assembly.

Electrical data Hydropack

PUMP	Rated power [kW]	Nominal Power [A]
1PM 120.1 - 160.1	3,0	7,62
1PM 200.1 - 240.1	4,0	7,62
1PM 290.1 ÷ 320.2	5,5	10,5
1PM 360.2 ÷ 440.2	7,5	14,1
1PM 480.2 ÷ 580.2	11,0	20,2

PUMP	Rated power [kW]	Nominal Power [A]
1PMH 120.1 ÷ 240.1	7,5	14,1
1PMH 290.1 ÷ 400.2	11,0	20,2
1PMH 440.2 ÷ 580.2	15,0	26,6

Accessories - Hydronic assembly

1PM - HYDROPACK WITH N° 1 PUMP

Head

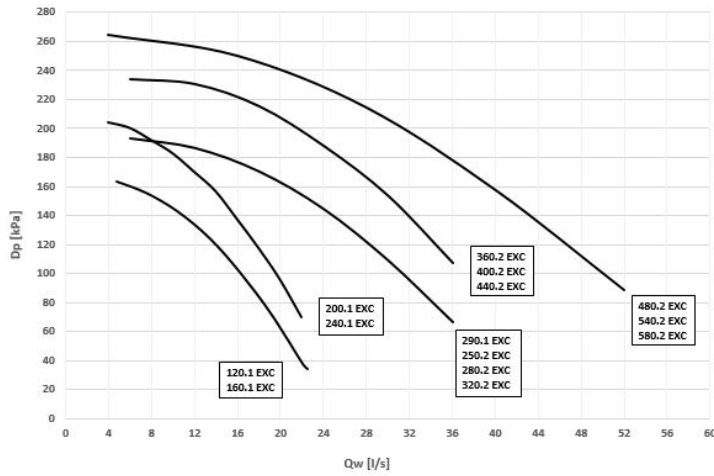

Dp = Pump head [kPa]
QW = Water flow-rate [l/s]

Power input

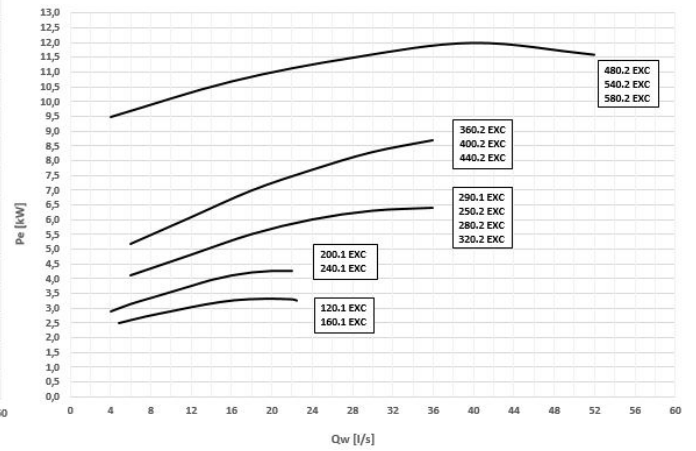

Dp = Pump head [kPa]
QW = Water flow-rate [l/s]

1PMH - HYDROPACK CON N° 1 POMPA ALTA PREVALENZA

Head

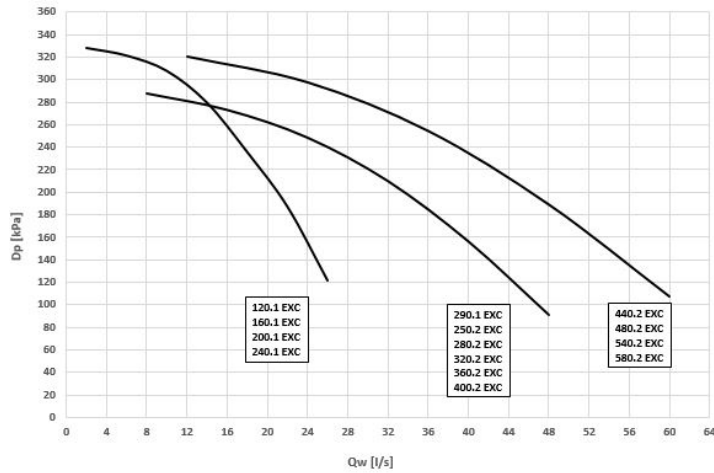

Dp = Pump head [kPa]
QW = Water flow-rate [l/s]

Power input

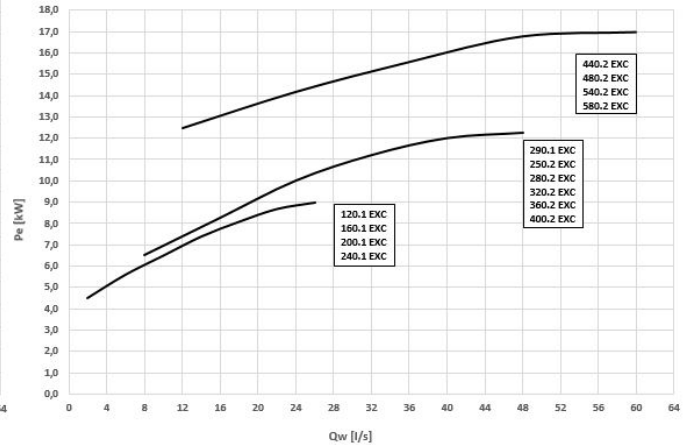

Dp = Pump head [kPa]
QW = Water flow-rate [l/s]

⚠ Caution: to obtain the available pressure values, you need to subtract the following from the head values represented in these diagrams:
Internal exchanger pressure drop
IFVX accessory –Steel mesh filter on the water side (where applicable)

1PMV/1PMVH - Hydropack user side with N° 1 inverter pump

Option supplied on the unit. Pumping unit made up of one electropump controlled by inverter to adapt to the different application conditions. It enables the automatic reduction of the liquid flow rate in critical conditions, avoiding blocks due to overloading and consequential intervention work by specialised technical personnel.

Through the inverter calibration, standard supplied, it is possible to adapt the pump flow-rate/head to the installation feature.

Centrifugal electric pump with the pump body made of cast iron and the impeller made of AISI 316 stainless steel (depending on the models). Mechanical seal using ceramic, carbon and EPDM elastomer components

Three-phase electric motor with IP55-protection. Complete with thermoformed insulated casing, fast fittings with insulated casing, no-return valve, safety valve, pressure gauges, system load safety pressure switch, stainless steel anti-freeze immersion resistances located at the intake and at the supply point.

In combination with the "IVFDT" - Variable flow-rate control option, it allows the water flow rate variation to the installation in part load operation to obtain the maximum unit efficiency and lower pumping unit consumption.

All water fittings are Victaulic.

1PMV = Hydropack with N° 1 inverter pump

1PMVH = Hydropack with N° 1 high static pressure inverter pump

CONNECTION DIAGRAM - GROUP WITH N° 1 INVERTER PUMP

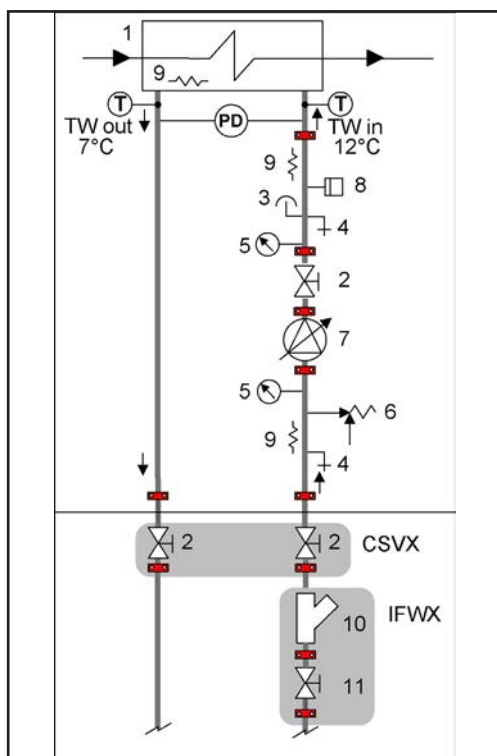

- 1 - Internal exchanger
- 2 - Cutoff valve - (CSVX Couple of manually operated shut-off valves)
- 3 - Purge valve
- 4 - Discharge stop valve
- 5 - Pressure gauge
- 6 - Safety valve (6 Bar)
- 7 - Packaged electric pump with high efficiency impeller
- 8 - System load safety pressure switch (it avoids the pump operation if water is not present)
- 9 - Antifreeze heater
- 10 - Steel mesh strainer water side (IFWX)
- 11 - Cutoff valve with quick joints

T - Temperature probe
PD - Differential pressure switch

TW in chilled water inlet
TW out chilled water outlet

The grey area indicates further optional components.

⚠ Provide hydraulic interceptions outside the unit ('CSVX - Couple of manually operated shut-off valves' option) to facilitate any possible extraordinary maintenance interventions.

⚠ The head and absorption graphs of the hydronic assembly refer to operation with pure water. In the presence of a mixture of water and glycol, please contact Clivet office to check the correct operating point of the hydronic assembly.

Electrical data Hydropack

PUMP	Rated power [kW]	Nominal Power [A]
1PMV 120.1 - 160.1	3,0	7,62
1PMV 200.1 - 240.1	4,0	7,62
1PMV 290.1 ÷ 320.1	5,5	10,5
1PMV 360.2 ÷ 440.2	7,5	14,1
1PMV 480.2 ÷ 580.2	11,0	20,2

PUMP	Rated power [kW]	Nominal Power [A]
1PMVH 120.1 - 240.1	7,5	14,1
1PMVH 290.1 ÷ 400.2	11,0	20,2
1PMVH 440.2 ÷ 580.2	15,0	26,6

Accessories - Hydronic assembly

1PMV - HYDROPACK WITH N° 1 INVERTER PUMP

Head - Size 120.1 ÷ 160.1

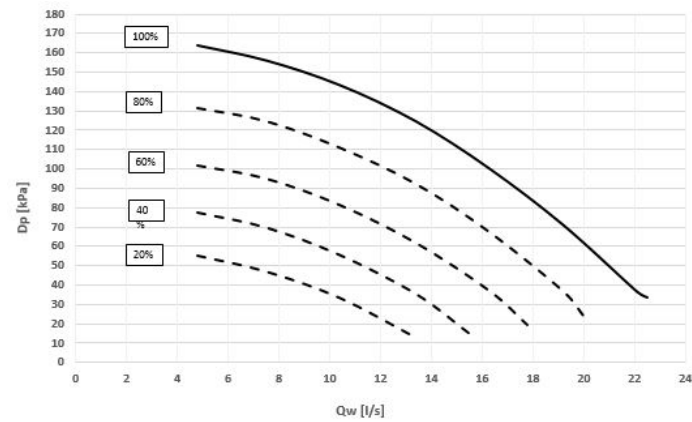

Dp = Pump head [kPa]
QW = Water flow-rate [l/s]

Power input - Size 120.1 ÷ 160.1

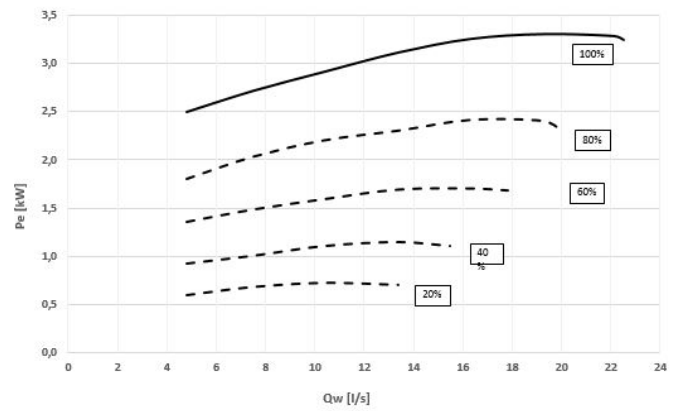

Pe = Power input [kW]
QW = Water flow-rate [l/s]

Head - Size 200.1 - 240.1

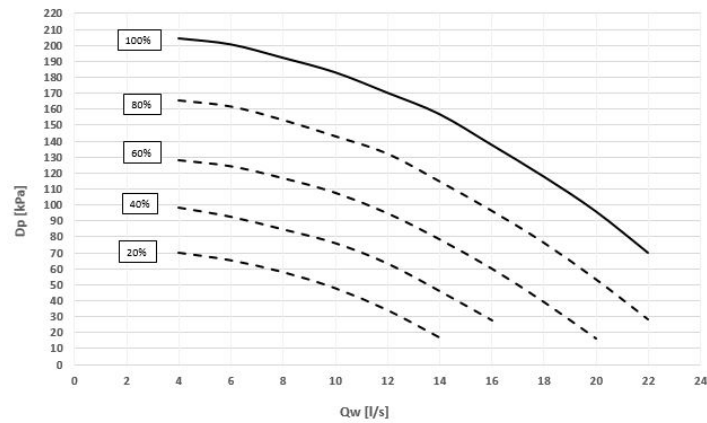

Dp = Pump head [kPa]
QW = Water flow-rate [l/s]

Power input - Size 200.1 - 240.1

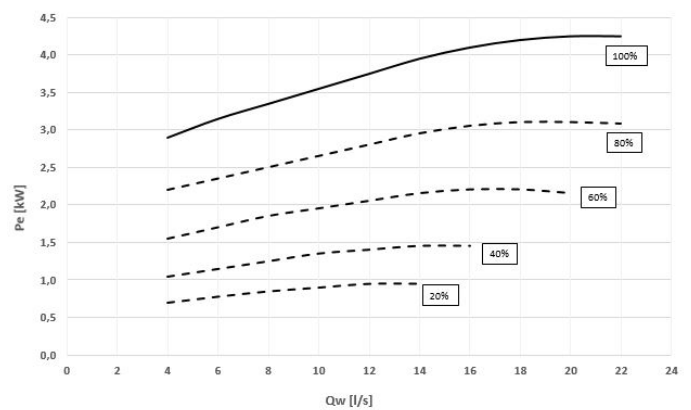

Pe = Power input [kW]
QW = Water flow-rate [l/s]

Head - Size 290.1 ÷ 320.2

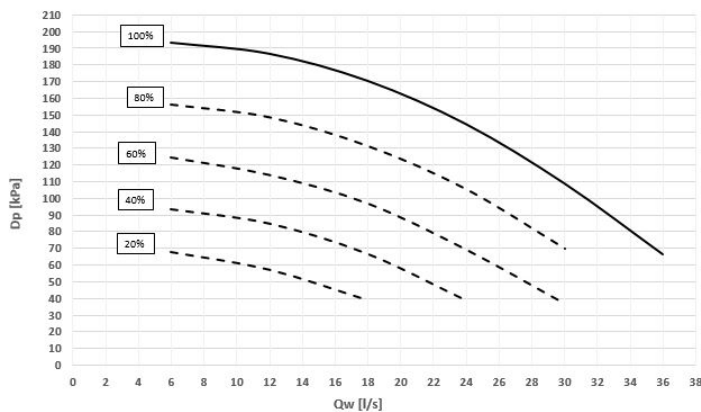

Dp = Pump head [kPa]
QW = Water flow-rate [l/s]

Power input - Size 290.1 ÷ 320.2

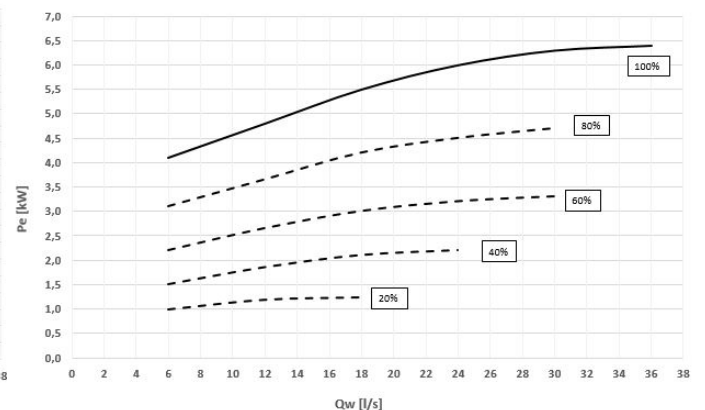

Pe = Power input [kW]
QW = Water flow-rate [l/s]

1PMV - HYDROPACK WITH N° 1 INVERTER PUMP

Head - Size 360.2 ÷ 440.2

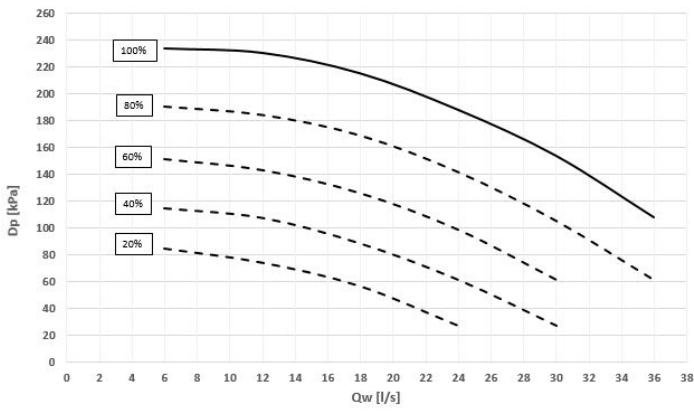

Dp = Pump head [kPa]
QW = Water flow-rate [l/s]

Power input - Size 360.2 ÷ 440.2

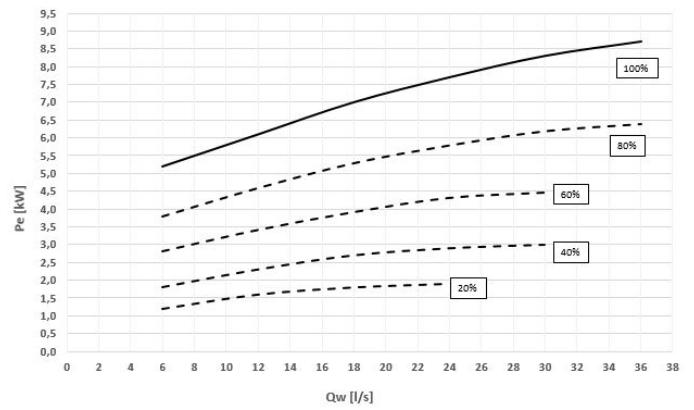

Pe = Power input [kW]
QW = Water flow-rate [l/s]

Head - Size 480.2 ÷ 580.2

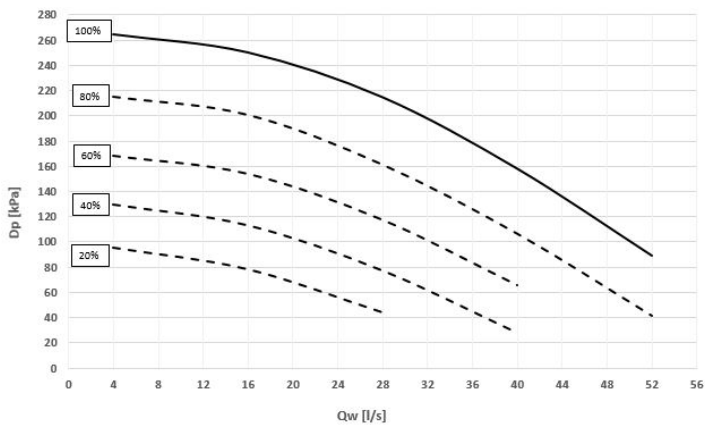

Dp = Pump head [kPa]
QW = Water flow-rate [l/s]

Power input - Size 480.2 ÷ 580.2

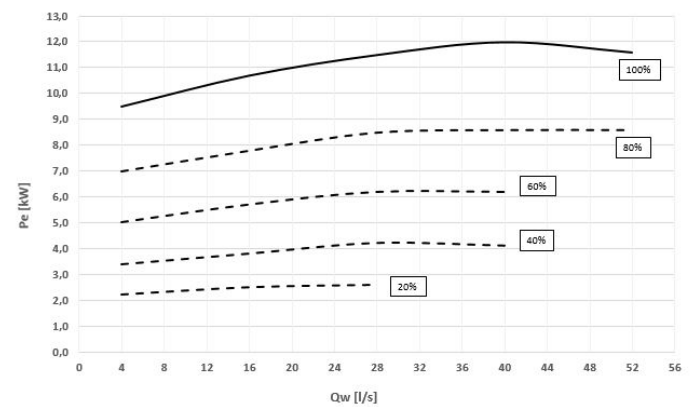

Pe = Power input [kW]
QW = Water flow-rate [l/s]

⚠ Caution: to obtain the available pressure values, you need to subtract the following from the head values represented in these diagrams:
Internal exchanger pressure drop
IFVX accessory –Steel mesh filter on the water side (where applicable)

Accessories - Hydronic assembly

1PMVH - HYDROPACK WITH N° 1 HIGH STATIC PRESSURE INVERTER PUMP

Head - Size 120.1 ÷ 240.1

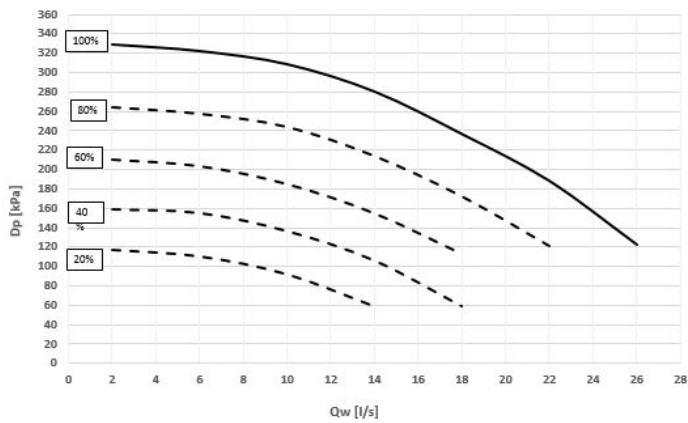

Dp = Pump head [kPa]
QW = Water flow-rate [l/s]

Power input - Size 120.1 ÷ 240.1

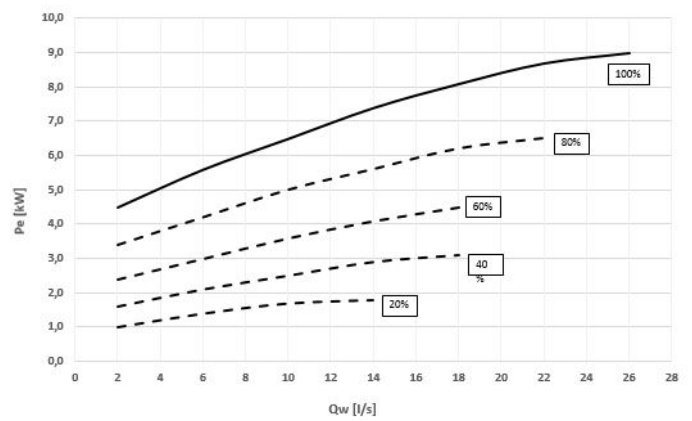

Pe = Power input [kW]
QW = Water flow-rate [l/s]

Head - Size 290.1 ÷ 400.2

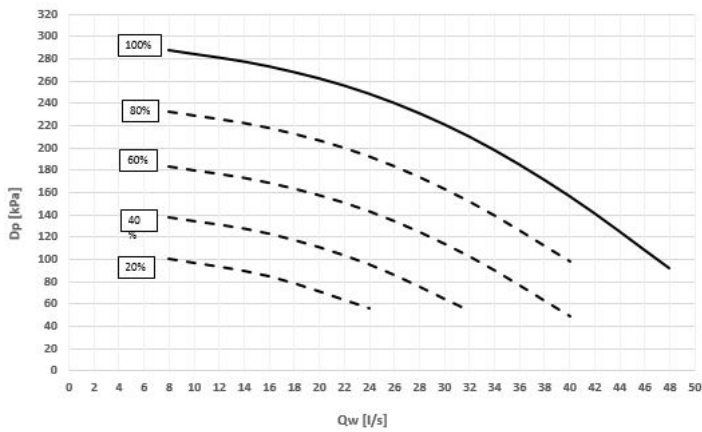

Dp = Pump head [kPa]
QW = Water flow-rate [l/s]

Power input - Size 290.1 ÷ 400.2

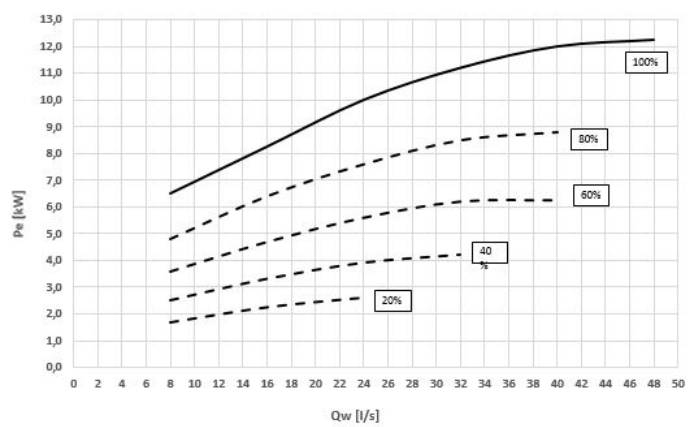

Pe = Power input [kW]
QW = Water flow-rate [l/s]

Head - Size 440.2 ÷ 580.2

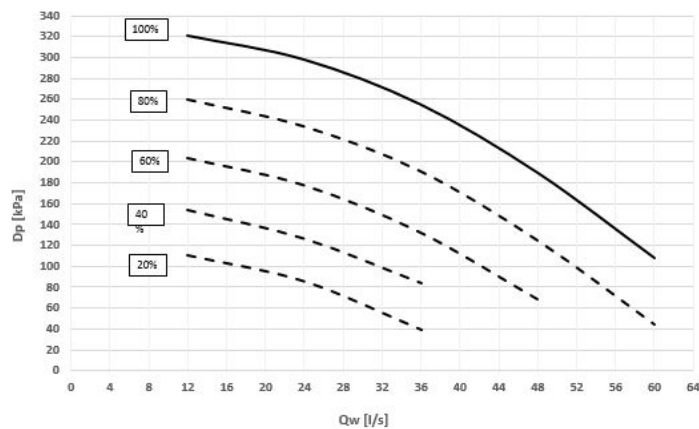

Dp = Pump head [kPa]
QW = Water flow-rate [l/s]

Power input - Size 440.2 ÷ 580.2

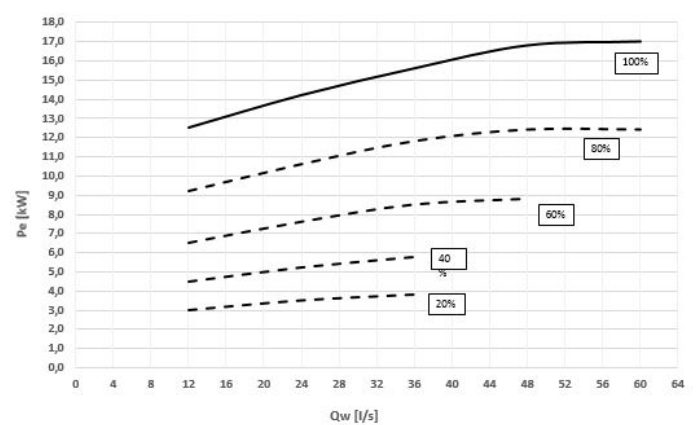

Pe = Power input [kW]
QW = Water flow-rate [l/s]

⚠ Caution: to obtain the available pressure values, you need to subtract the following from the head values represented in these diagrams:
Internal exchanger pressure drop
IFVX accessory –Steel mesh filter on the water side (where applicable)

2PM/2PMH - HydroPack with N° 2 pumps

Option supplied built-in the unit. Pumping unit made up of two electric pumps laid out in parallel, with auto-adaptive modular logic activation. It enables the automatic reduction of the liquid flow-rate in critical conditions, avoiding blocks due to overloading and consequential intervention work by specialised technical personnel.

Centrifugal electric pump, with the pump body made of cast iron and the impeller made of AISI 316 stainless steel.

Mechanical seal using ceramic, carbon and EPDM elastomer components.

Three-phase electric motor with IP55 degree of protection. Complete with a thermoformed insulating casing, quick connections with insulated casing, non-return valve, safety valve, pressure gauges, system safety pressure switch, stainless steel antifreeze, intake, immersion-type heaters.

All water fittings are Victaulic.

2PM = Hydropack with N° 2 pump

2PMH = Hydropack with N° 2 high static pressure pump

CONNECTION DIAGRAM - GROUP WITH N° 2 PUMPS

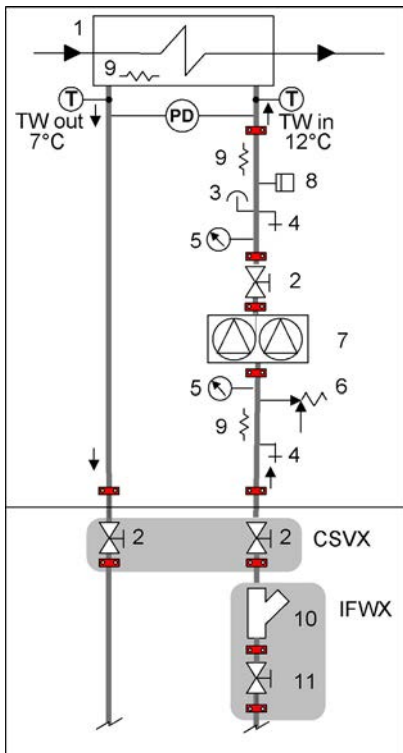

- 1 - Internal exchanger
- 2 - Cutoff valve - (CSVX Couple of manually operated shut-off valves)
- 3 - Purge valve
- 4 - Discharge stop valve
- 5 - Pressure gauge
- 6 - Safety valve (6 Bar)
- 7 - Packaged electric pump with high efficiency impeller
- 8 - System load safety pressure switch (it avoids the pump operation if water is not present)
- 9 - Antifreeze heater
- 10 - Steel mesh strainer water side (IFWX)
- 11 - Cutoff valve with quick joints

T - Temperature probe
PD - Differential pressure switch

TW in chilled water inlet
TW out chilled water outlet

The grey area indicates further optional components.

⚠ Provide hydraulic interceptions outside the unit ('CSVX - Couple of manually operated shut-off valves' option) to facilitate any possible extraordinary maintenance interventions.

⚠ The head and absorption graphs of the hydronic assembly refer to operation with pure water. In the presence of a mixture of water and glycol, please contact Clivet office to check the correct operating point of the hydronic assembly.

Electrical data Hydropack

PUMP	Rated power [kW]	Nominal Current [A]
2PM 120.1 - 160.1	2 x 2,2	2 x 4,6
2PM 200.1 ÷ 400.2	2 x 4,0	2 x 7,6
2PM 440.2 ÷ 580.2	2 x 7,5	2 x 15,2

PUMP	Rated power [kW]	Nominal Current [A]
2PMH 120.1 - 160.1	2 x 4,0	2 x 7,6
2PMH 200.1 ÷ 400.2	2 x 7,5	2 x 10,2
2PMH 440.2 ÷ 580.2	2 x 11	2 x 20,2

Accessories - Hydronic assembly

2PM- HYDROPACK WITH N° 2 PUMPS

Head

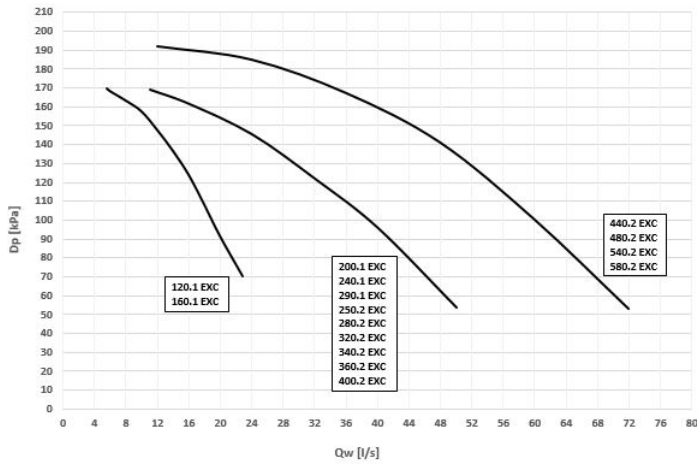

Dp = Pump head [kPa]
QW = Water flow-rate [l/s]

Power input

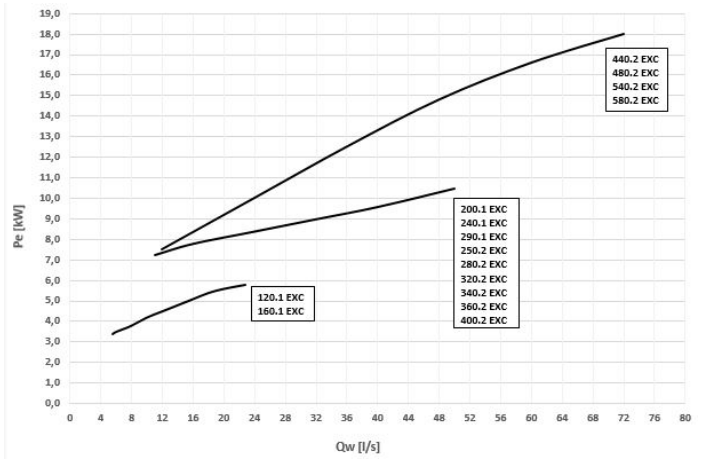

Pe = Power input [kW]
QW = Water flow-rate [l/s]

2PMH - HYDROPACK WITH N° 2 HIGH STATIC PRESSURE PUMPS

Head

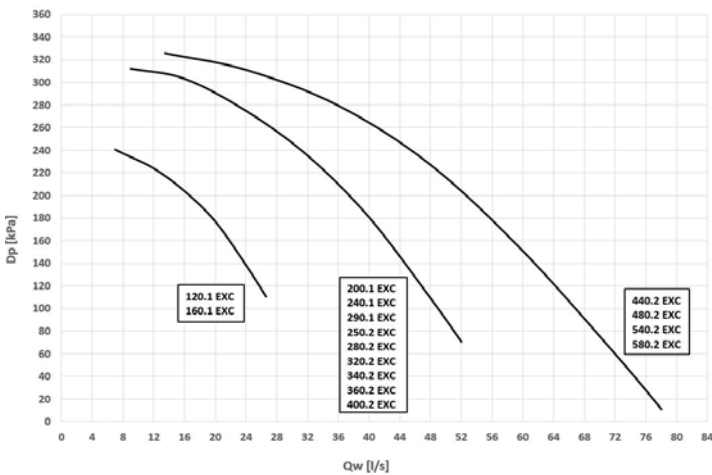

Dp = Pump head [kPa]
QW = Water flow-rate [l/s]

Power input

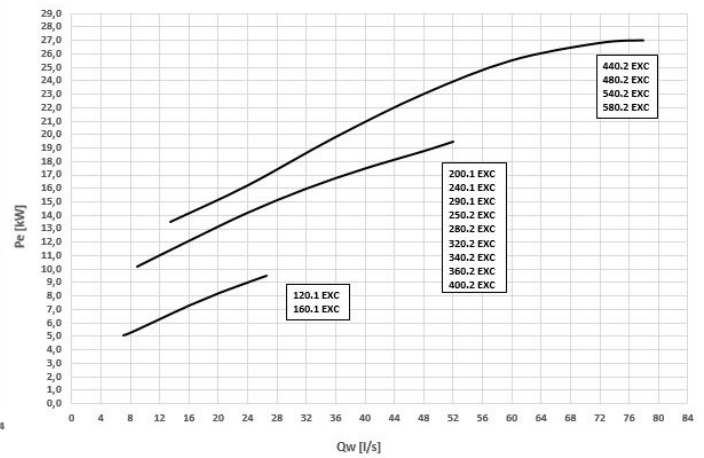

Pe = Power input [kW]
QW = Water flow-rate [l/s]

⚠ Caution: to obtain the available pressure values, you need to subtract the following from the head values represented in these diagrams:
Internal exchanger pressure drop
IFVX accessory –Steel mesh filter on the water side (where applicable)

2PMV/2PMVH - Hydropack user side with no. 2 of inverter pumps

Option supplied on the unit. Pumping unit consisting of parallel electric pumps and controlled by inverter to adapt to the different application conditions.

It enables the automatic reduction of the liquid flow-rate in critical conditions, avoiding blocks due to overloading and consequential intervention work by specialised technical personnel.

Through the inverter calibration, standard supplied, it is possible to adapt the pump flow-rate/head to the installation feature.

Centrifugal electric pump with impeller made with AISI 304 steel and AISI 304 stainless steel body or grey cast iron (depending on models).

Mechanical seal using ceramic, carbon and EPDM elastomer components.

Three-phase electric motor with IP44-protection. Complete with thermoformed insulated casing, quick connections with insulated casing, non return valve, safety valve, pressure gauges, system load safety pressure switch, stainless steel antifreeze immersion heaters located at the return and supply point.

In combination with the "IVFDT" - Variable flow-rate control option, it allows the water flow-rate variation to the installation in part load operation to obtain the maximum unit efficiency and lower pumping unit consumption.

All water fittings are Victaulic.

2PMV = Hydropack with N° 2 inverter pump

2PMVH = Hydropack with N° 2 high static pressure inverter pump

CONNECTION DIAGRAM - GROUP WITH 2 INVERTER PUMPS

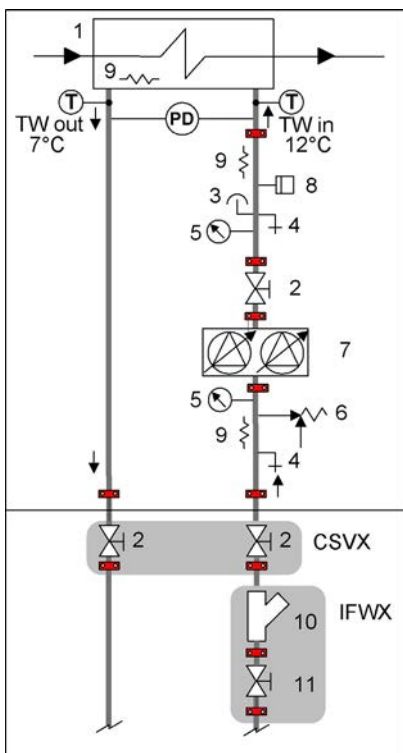

- 1 - Internal exchanger
- 2 - Cutoff valve - (CSVX Couple of manually operated shut-off valves)
- 3 - Purge valve
- 4 - Discharge stop valve
- 5 - Pressure gauge
- 6 - Safety valve (6 Bar)
- 7 - Packaged electric pump with high efficiency impeller
- 8 - System load safety pressure switch (it avoids the pump operation if water is not present)
- 9 - Antifreeze heater
- 10 - Steel mesh strainer water side (IFWX)
- 11 - Cutoff valve with quick joints

T - Temperature probe
PD - Differential pressure switch

TW in chilled water inlet
TW out chilled water outlet

The grey area indicates further optional components.

⚠ Provided with hydraulic interceptions to the outside of the unit (option 'CSVX - A pair of manually operated shut-off valves') to facilitate any major maintenance operations

⚠ The head and absorption graphs of the hydronic assembly refer to operation with pure water. In the presence of a mixture of water and glycol, please contact Clivet office to check the correct operating point of the hydronic assembly.

Electrical data Hydropack

PUMP	Rated power [kW]	Nominal Current [A]
2PM 120.1 - 160.1	2 x 2,2	2 x 4,6
2PM 200.1 ÷ 400.2	2 x 4,0	2 x 7,6
2PM 440.2 ÷ 580.2	2 x 7,5	2 x 15,2

PUMP	Rated power [kW]	Nominal Current [A]
2PMH 120.1 - 160.1	2 x 4,0	2 x 7,6
2PMH 200.1 ÷ 400.2	2 x 7,5	2 x 10,2
2PMH 440.2 ÷ 580.2	2 x 11	2 x 20,2

Accessories - Hydronic assembly

2PMV - HYDROPACK WITH N° 2 INVERTER PUMPS

Head - Size 120.1 ÷ 160.1

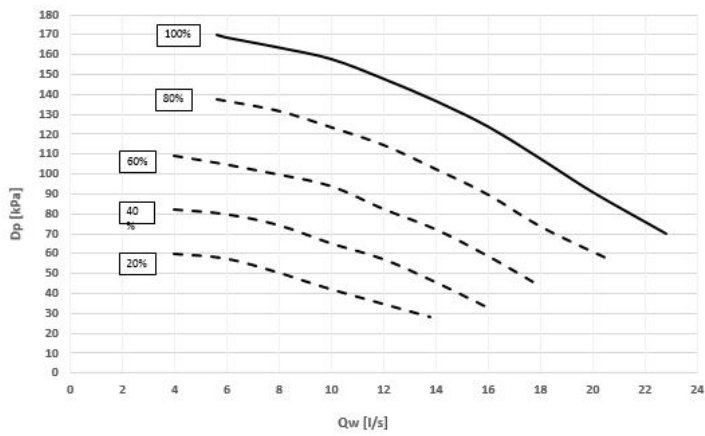

Dp = Pump head [kPa]
QW = Water flow-rate [l/s]

Power input - Size 120.1 ÷ 160.1

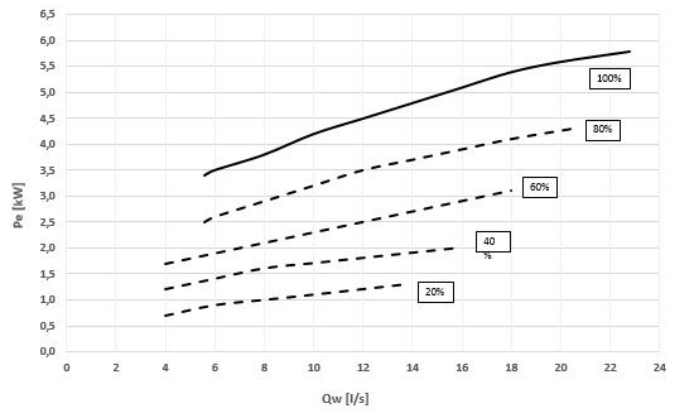

Pe = Power input [kW]
QW = Water flow-rate [l/s]

Head - Size 200.1 ÷ 400.2

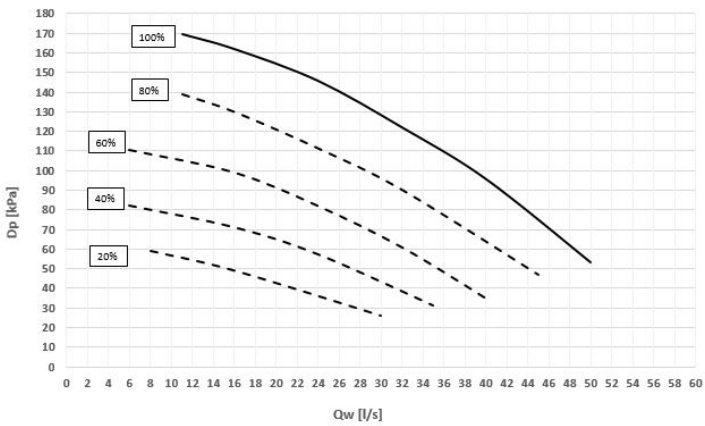

Dp = Pump head [kPa]
QW = Water flow-rate [l/s]

Power input - Size 200.1 ÷ 400.2

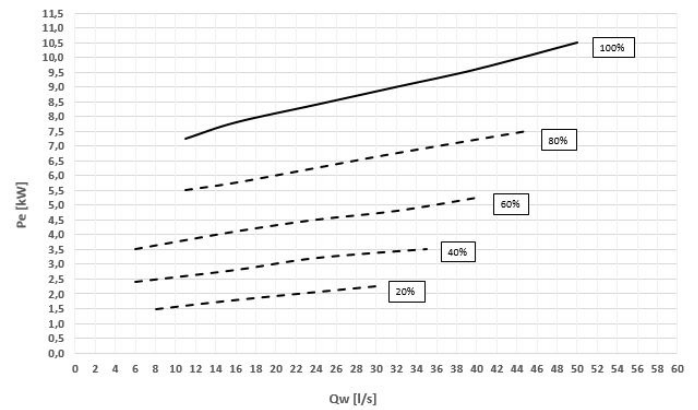

Pe = Power input [kW]
QW = Water flow-rate [l/s]

Head - Size 440.2 ÷ 580.2

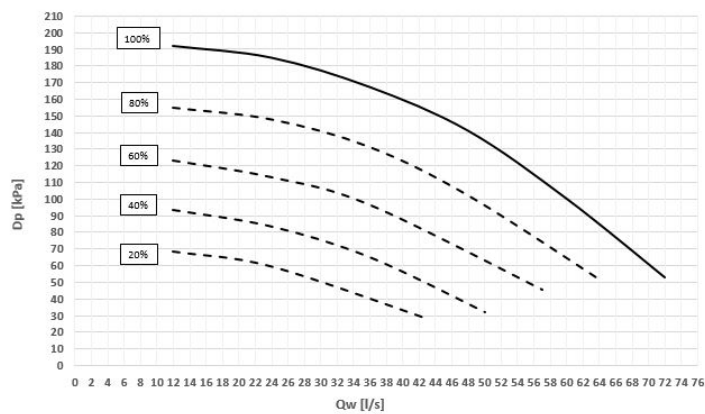

Dp = Pump head [kPa]
QW = Water flow-rate [l/s]

Power input - Size 440.2 ÷ 580.2

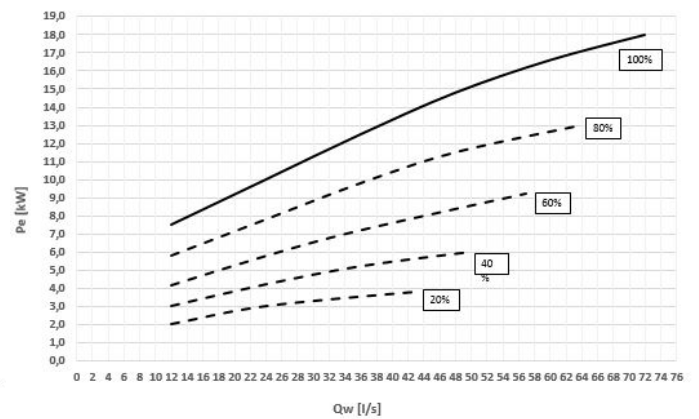

Pe = Power input [kW]
QW = Water flow-rate [l/s]

2PMVH - HYDROPACK WITH N° 2 HIGH STATIC PRESSURE INVERTER PUMPS

Head - Size 120.1 ÷ 160.1

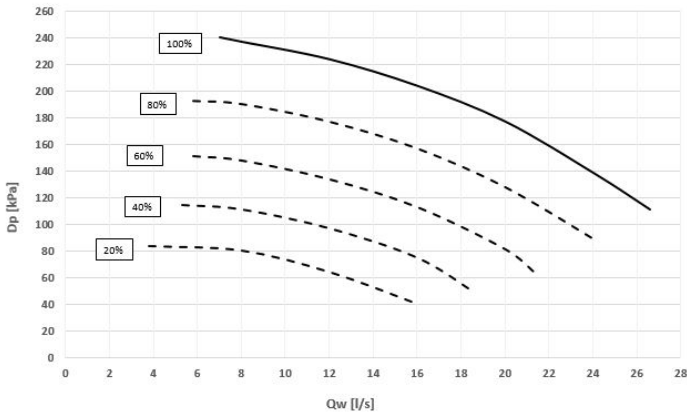

Dp = Pump head [kPa]
QW = Water flow-rate [l/s]

Power input - Size 120.1 ÷ 160.1

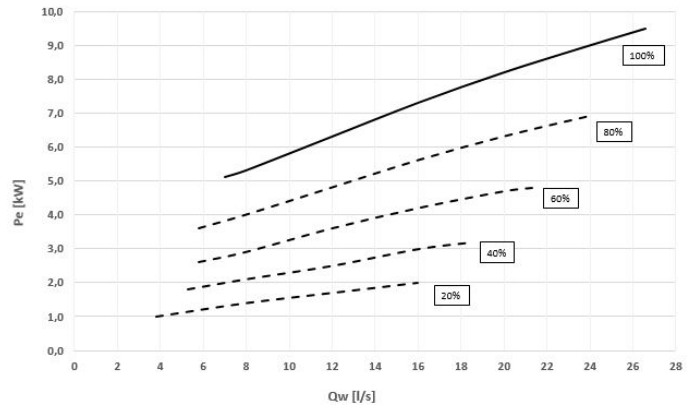

Pe = Power input [kW]
QW = Water flow-rate [l/s]

Head - Size 200.1 ÷ 400.2

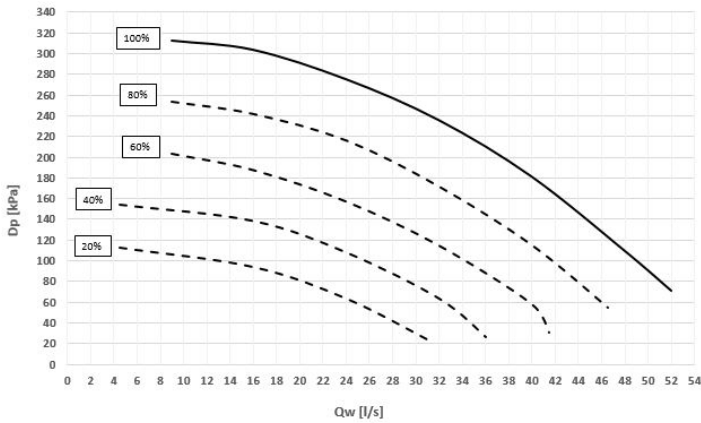

Dp = Pump head [kPa]
QW = Water flow-rate [l/s]

Power input - Size 200.1 ÷ 400.2

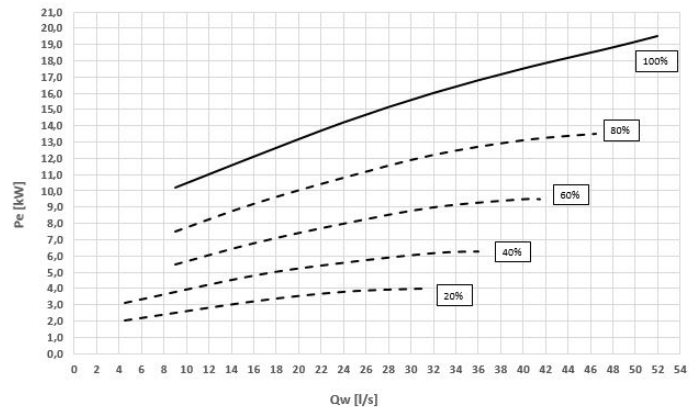

Pe = Power input [kW]
QW = Water flow-rate [l/s]

Head - Size 440.2 ÷ 580.2

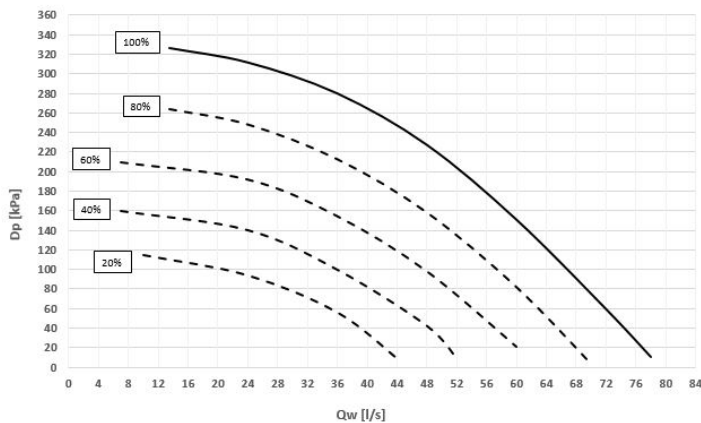

Dp = Pump head [kPa]
QW = Water flow-rate [l/s]

Power input - Size 440.2 ÷ 580.2

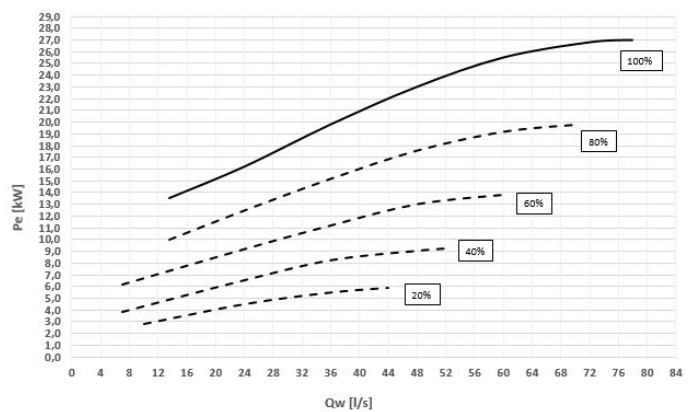

Pe = Power input [kW]
QW = Water flow-rate [l/s]

⚠ Caution: to obtain the available pressure values, you need to subtract the following from the head values represented in these diagrams:
Internal exchanger pressure drop
IFVX accessory –Steel mesh filter on the water side (where applicable)

Arrangement of hydronic groups

The hydronic assemblies are supplied as an built-in options

Compared to the standard unit, the length of the complete hydronic assembly varies according to the following indications

- ⚠ With the standard acoustic configuration, if the hydronic assemblies are installed on board, they are supplied without casing.
- ⚠ With the acoustic configuration with compressor soundproofing if the hydronic assemblies are installed on board, they are supplied without casing.
- ⚠ With the super-silenced acoustic configuration, if the hydronic assemblies are installed on board, they are supplied with casing.

Size 120.1 ÷ 320.2

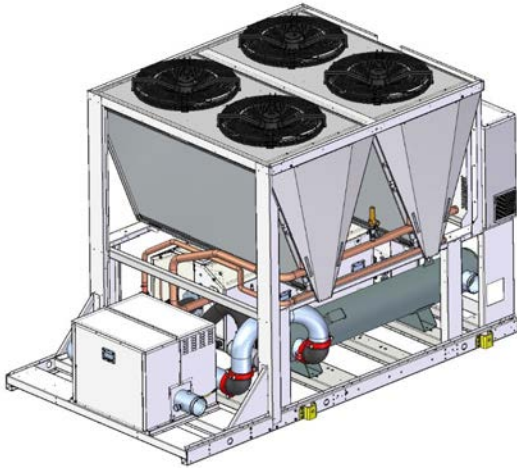

SIZE		120.1	160.1	200.1	240.1	290.1	250.2	280.2	320.2
Standard length	[mm]	2925	2925	4175	4175	5425	5425	5425	5425
Length with hydronic assembly option	[mm]	3925	3925	5175	5175	6425	6425	6425	6425

Size 360.2 ÷ 580.2

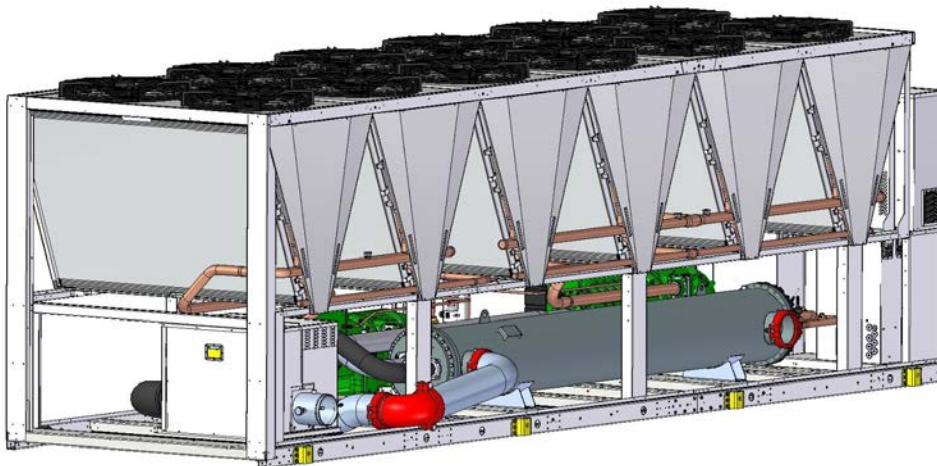

SIZE		360.2	400.2	440.2	480.2	540.2	580.2
Standard length	[mm]	6675	6675	7925	7925	9175	10425
Length with hydronic assembly option	[mm]	6675	6675	7925	7925	9175	10425

SIZE 120.1 - 160.1 ST/SC/EN

DAA5Z0009 REV01
DATA/DATE 30/10/2019

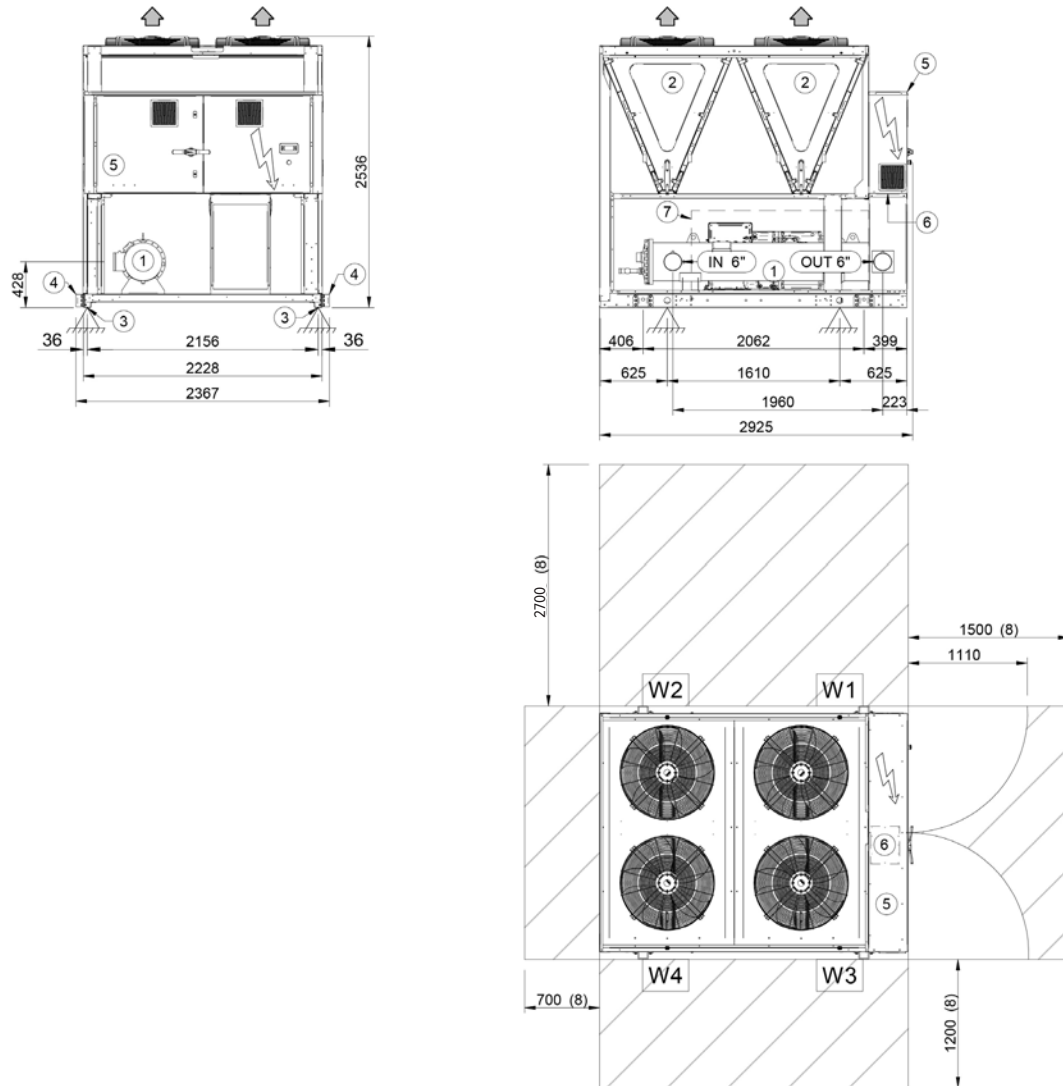

1. Internal exchanger (Evaporator)
2. Esternal exchanger (Condenser)
3. Unit fixing holes
4. Lifting brackets (Removable)
5. Electrical panel
6. Power input
7. Sound proof enclosure, only SC and EN version
8. Clearance access reccomended

SIZE		120.1		160.1	
		ST	SC/EN	ST	SC/EN
Length	mm	2925	2925	2925	2925
Depth	mm	2228	2228	2228	2228
Height	mm	2536	2536	2536	2536
W1 Supporting point	kg	744	801	772	829
W2 Supporting point	kg	607	659	631	683
W3 Supporting point	kg	705	738	750	783
W4 Supporting point	kg	567	596	608	638
Operating weight	kg	2623	2794	2761	2933
Shipping weight	kg	2435	2605	2515	2685

The presence of optional accessories may result in a substantial variation of the weights shown in the table. Fan diffusers are separately supplied.

Dimensional drawings

SIZE 200.1 - 240.1 ST/SC/EN

DAA5Z0003 REV01
DATA/DATE 21/10/2019

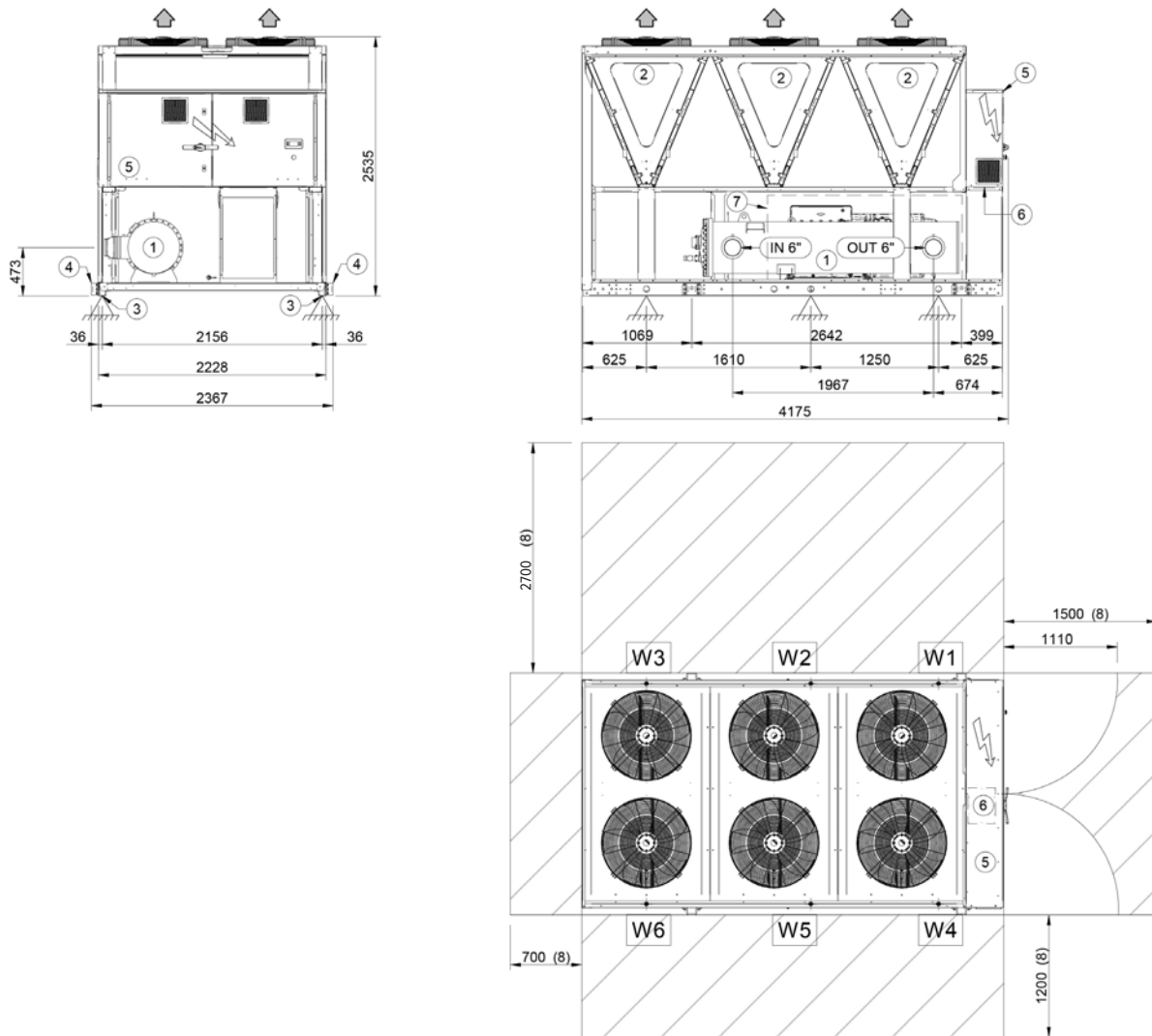

1. Internal exchanger (Evaporator)
2. Esternal exchanger (Condenser)
3. Unit fixing holes
4. Lifting brackets (Removable)
5. Electrical panel
6. Power input
7. Sound proof enclosure, only SC and EN version
8. Clearance access reccomended

SIZE		200.1		SC/EN	
		ST	SC	ST	SC
Length	mm	4175	4175	4175	4175
Depth	mm	2228	2228	2228	2228
Height	mm	2535	2535	2535	2535
W1 Supporting point	kg	725	762	726	763
W2 Supporting point	kg	952	1089	954	1091
W3 Supporting point	kg	286	276	287	277
W4 Supporting point	kg	663	675	665	677
W5 Supporting point	kg	879	926	883	930
W6 Supporting point	kg	315	312	316	313
Operating weight	kg	3820	4040	3831	4051
Shipping weight	kg	3410	3630	3438	3658

The presence of optional accessories may result in a substantial variation of the weights shown in the table. Fan diffusers are separately supplied.

SIZE 290.1 ST/SC/EN

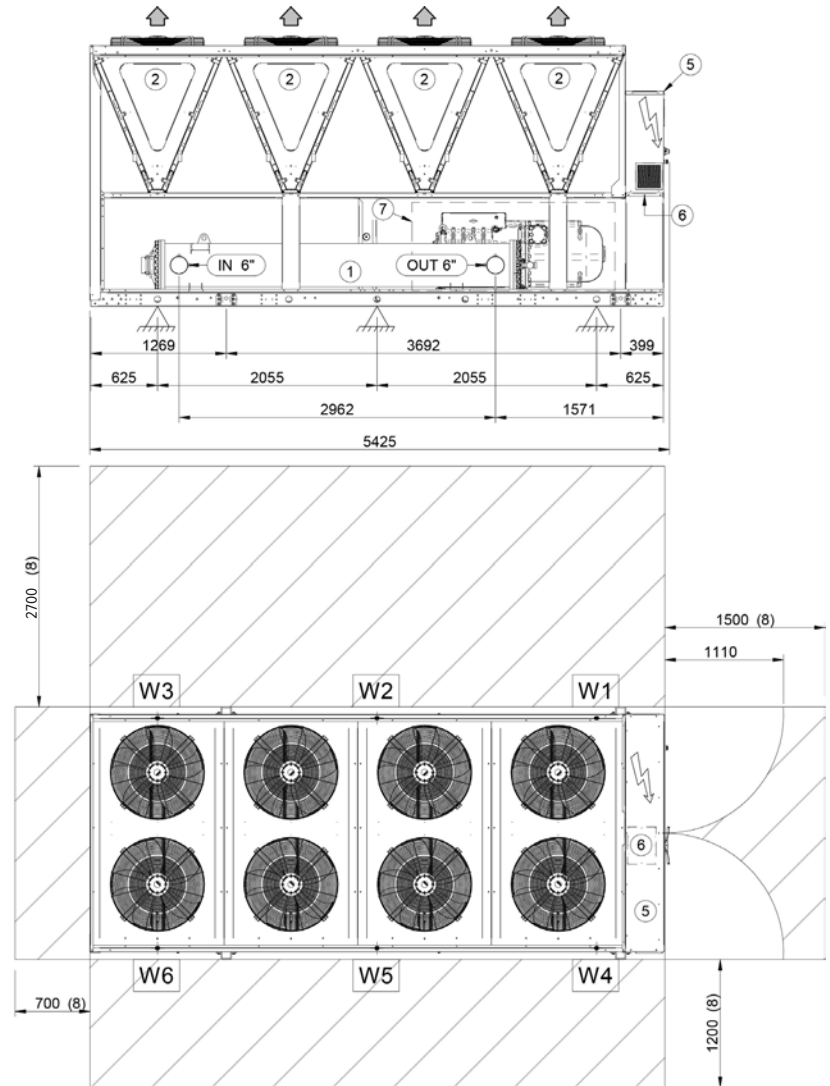
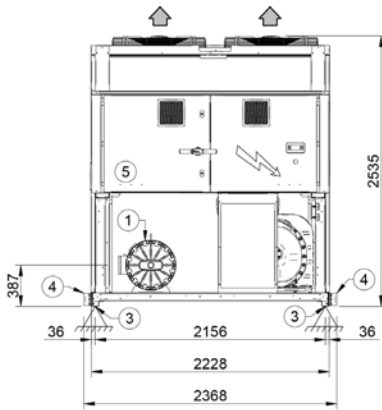

1. Internal exchanger (Evaporator)
2. Esternal exchanger (Condenser)
3. Unit fixing holes
4. Lifting brackets (Removable)
5. Electrical panel
6. Power input
7. Sound proof enclosure, only SC and EN version
8. Clearance access reccomended

SIZE		290.1	
		ST	SC/EN
Length	mm	5425	5425
Depth	mm	2228	2228
Height	mm	2535	2535
W1 Supporting point	kg	907	987
W2 Supporting point	kg	937	1035
W3 Supporting point	kg	294	280
W4 Supporting point	kg	638	666
W5 Supporting point	kg	874	908
W6 Supporting point	kg	497	492
Operating weight	kg	4147	4368
Shipping weight	kg	3827	4047

The presence of optional accessories may result in a substantial variation of the weights shown in the table. Fan diffusers are separately supplied.

Dimensional drawings

SIZE 250.2 - 280.2 - 320.2 ST/SC/EN

DAA5Z0007 REV01
DATA/DATE 24/10/2019

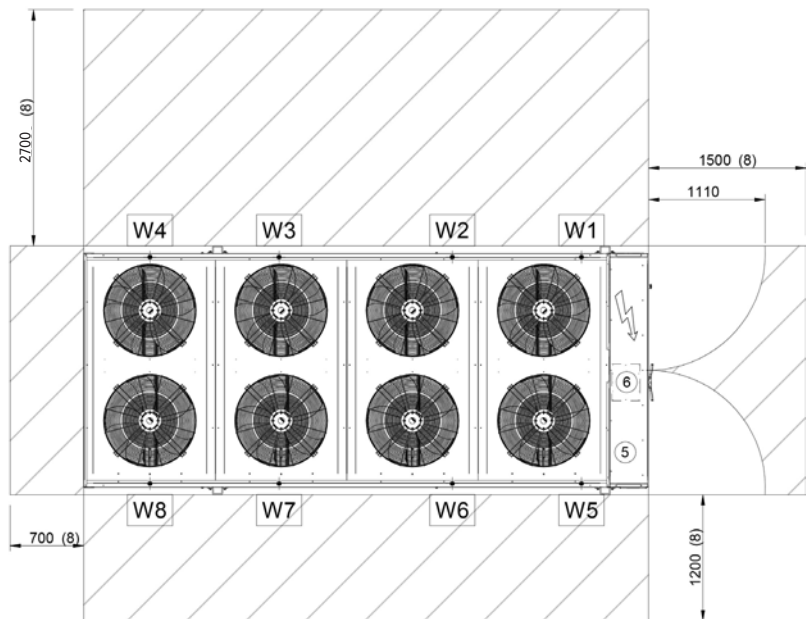
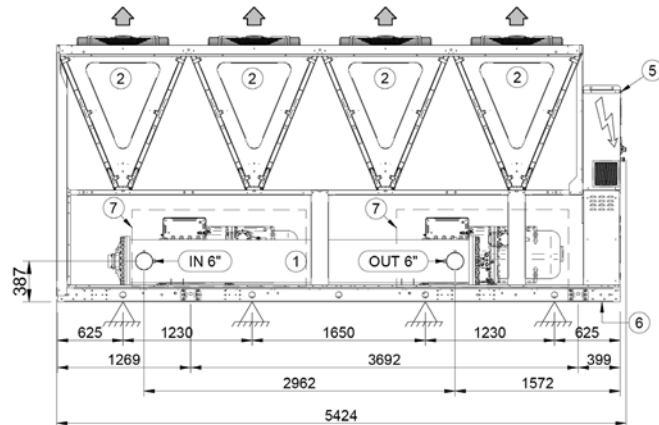
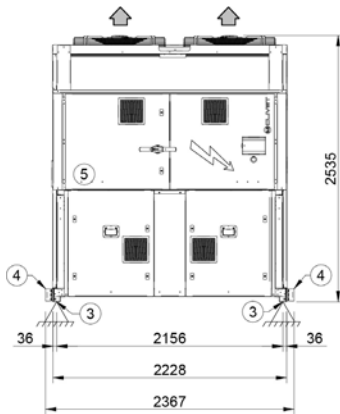

1. Internal exchanger (Evaporator)
2. External exchanger (Condenser)
3. Unit fixing holes
4. Lifting brackets (Removable)
5. Electrical panel
6. Power input
7. Sound proof enclosure, only SC and EN version
8. Clearance access recommended

SIZE		250.2		280.2		320.2	
		ST	SC/EN	ST	SC/EN	ST	SC/EN
Length	mm	5425	5425	5425	5425	5425	5425
Depth	mm	2228	2228	2228	2228	2228	2228
Height	mm	2535	2535	2535	2535	2535	2535
W1 Supporting point	kg	679	725	679	725	680	725
W2 Supporting point	kg	629	715	630	716	630	716
W3 Supporting point	kg	787	886	788	886	789	887
W4 Supporting point	kg	371	403	371	403	372	404
W5 Supporting point	kg	556	569	556	570	556	570
W6 Supporting point	kg	542	568	544	569	545	570
W7 Supporting point	kg	614	643	615	645	616	646
W8 Supporting point	kg	420	429	421	430	422	431
Operating weight	kg	4598	4938	4604	4944	4610	4949
Shipping weight	kg	4290	4630	4306	4646	4319	4659

The presence of optional accessories may result in a substantial variation of the weights shown in the table. Fan diffusers are separately supplied.

SIZE 360.2 - 400.2 ST/SC/EN

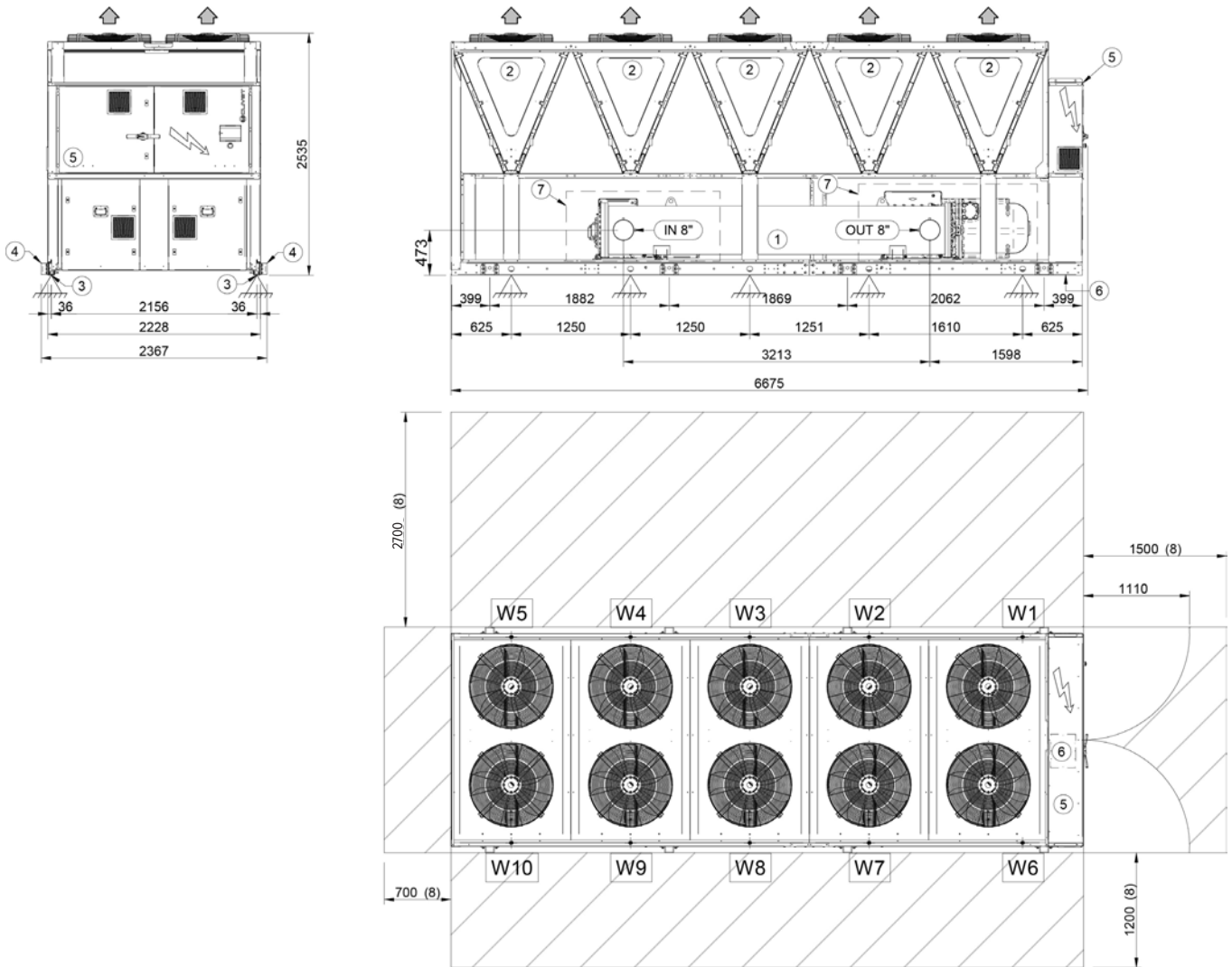

1. Internal exchanger (Evaporator)
2. Esternal exchanger (Condenser)
3. Unit fixing holes
4. Lifting brackets (Removable)
5. Electrical panel
6. Power input
7. Sound proof enclosure, only SC and EN version
8. Clearance access recommended

SIZE		360.2		400.2	
		ST	SC/EN	ST	SC/EN
Length	mm	6675	6675	6675	6675
Depth	mm	2228	2228	2228	2228
Height	mm	2535	2535	2535	2535
W1 Supporting point	kg	806	863	804	861
W2 Supporting point	kg	1013	1150	1016	1152
W3 Supporting point	kg	114	83	111	80
W4 Supporting point	kg	951	1089	955	1093
W5 Supporting point	kg	166	161	168	162
W6 Supporting point	kg	697	716	688	708
W7 Supporting point	kg	945	992	952	999
W8 Supporting point	kg	217	206	207	196
W9 Supporting point	kg	887	928	898	940
W10 Supporting point	kg	160	159	163	161
Operating weight	kg	5956	6347	5962	6823
Shipping weight	kg	5408	5799	5430	6195

The presence of optional accessories may result in a substantial variation of the weights shown in the table. Fan diffusers are separately supplied.

Dimensional drawings

DAA5Z0005 REV01
DATA/DATE 22/10/2019

SIZE 440.2 - 480.2 ST/SC/EN

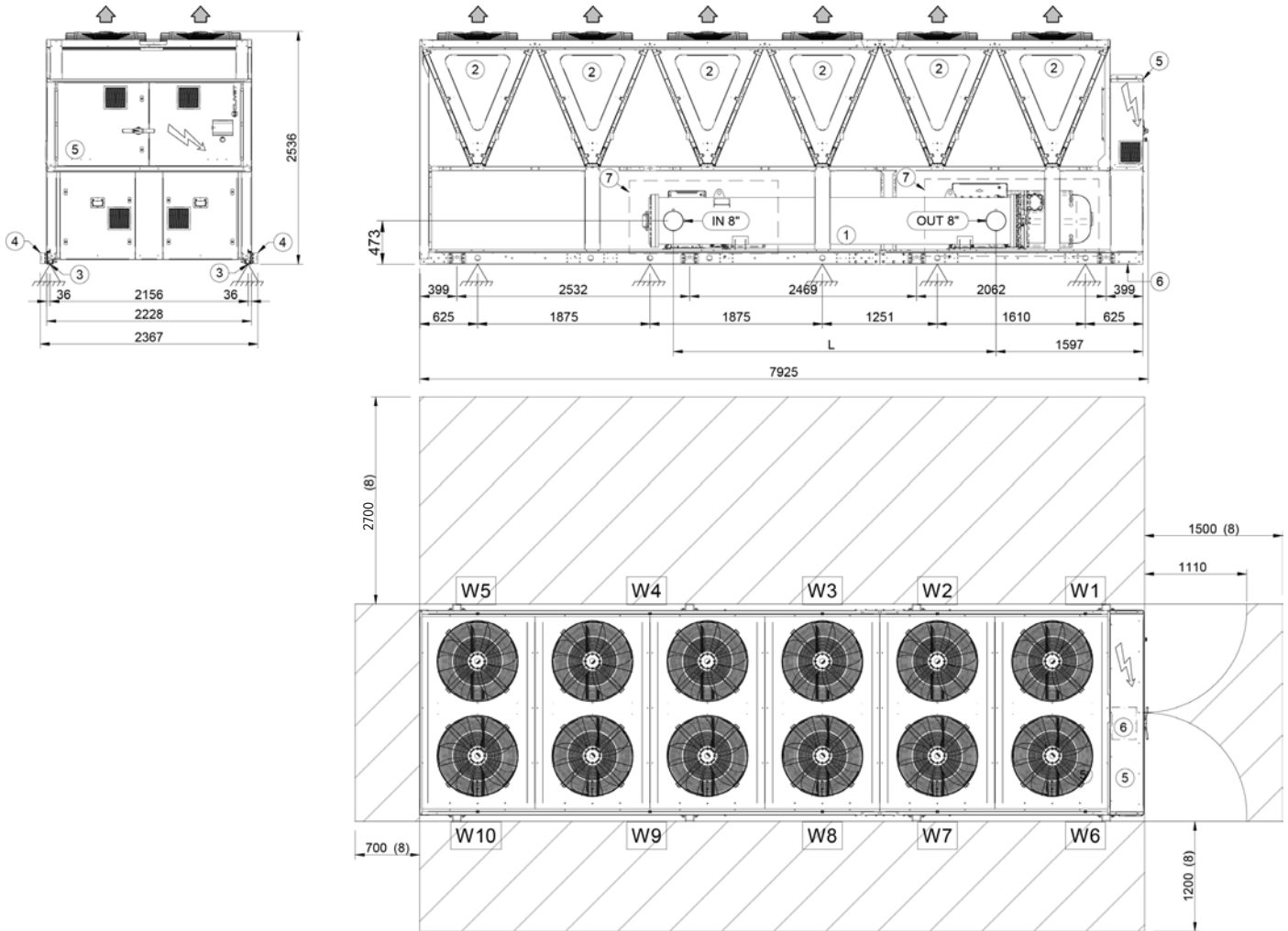

1. Internal exchanger (Evaporator)
2. Esternal exchanger (Condenser)
3. Unit fixing holes
4. Lifting brackets (Removable)
5. Electrical panel
6. Power input
7. Sound proof enclosure, only SC and EN version
8. Clearance access recommended

SIZE		440.2		480.2	
		ST	SC/EN	ST	SC/EN
Length	mm	7925	7925	7925	7925
Depth	mm	2228	2228	2228	2228
Height	mm	2536	2536	2536	2536
L	mm	3510	3510	3210	3210
W1 Supporting point	kg	840	899	836	896
W2 Supporting point	kg	891	1006	856	968
W3 Supporting point	kg	531	566	651	696
W4 Supporting point	kg	865	962	1111	1236
W5 Supporting point	kg	193	182	177	164
W6 Supporting point	kg	707	727	672	692
W7 Supporting point	kg	804	845	770	808
W8 Supporting point	kg	663	672	731	746
W9 Supporting point	kg	708	737	807	849
W10 Supporting point	kg	230	227	224	219
Operating weight	kg	6432	6823	6835	7274
Shipping weight	kg	5805	6195	6280	6720

The presence of optional accessories may result in a substantial variation of the weights shown in the table. Fan diffusers are separately supplied.

SIZE 540.2 ST/SC/EN

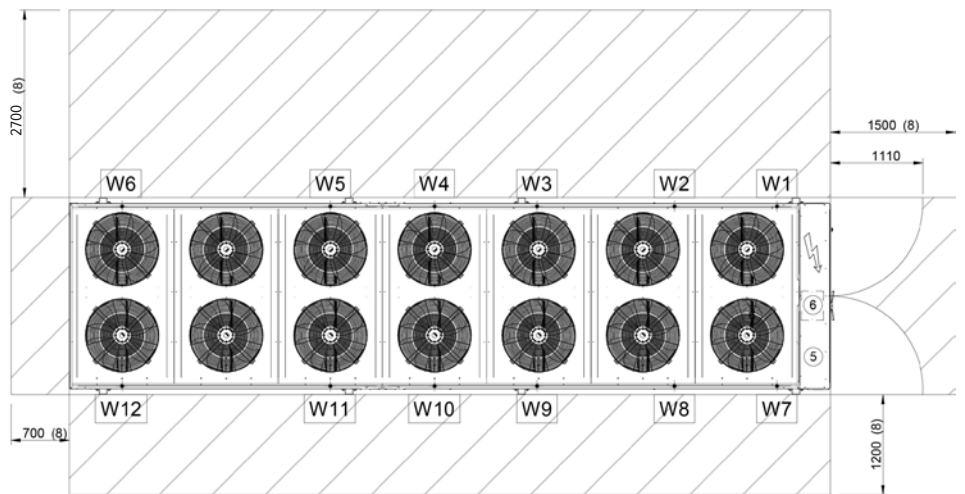
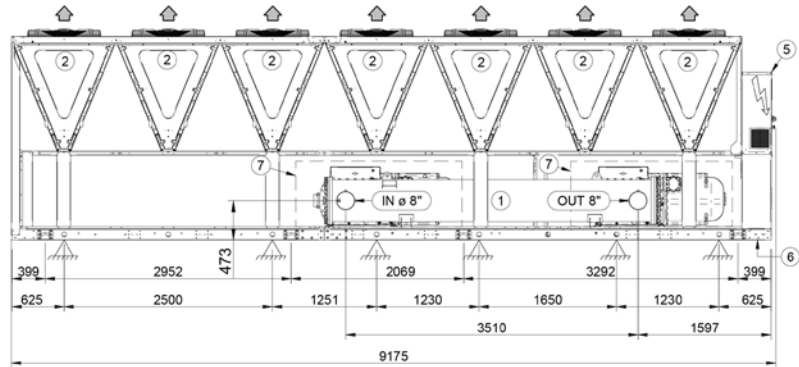
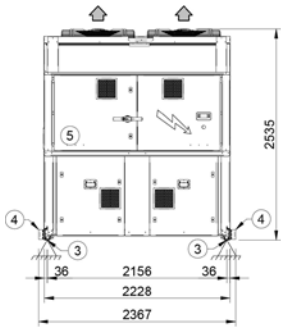

1. Internal exchanger (Evaporator)
2. Esternal exchanger (Condenser)
3. Unit fixing holes
4. Lifting brackets (Removable)
5. Electrical panel
6. Power input
7. Sound proof enclosure, only SC and EN version
8. Clearance access recommended

SIZE		540.2	
		ST	SC/EN
Length	mm	9175	9175
Depth	mm	2228	2228
Height	mm	2535	2535
W1 Supporting point	kg	706	745
W2 Supporting point	kg	957	1082
W3 Supporting point	kg	423	423
W4 Supporting point	kg	1034	1198
W5 Supporting point	kg	375	375
W6 Supporting point	kg	319	319
W7 Supporting point	kg	558	571
W8 Supporting point	kg	863	905
W9 Supporting point	kg	565	565
W10 Supporting point	kg	828	884
W11 Supporting point	kg	330	330
W12 Supporting point	kg	321	321
Operating weight	kg	7279	7718
Shipping weight	kg	6684	7124

The presence of optional accessories may result in a substantial variation of the weights shown in the table. Fan diffusers are separately supplied.

Dimensional drawings

SIZE 580.2 ST/SC/EN

DAA5Z0006 REV01
DATA/DATE 23/10/2019

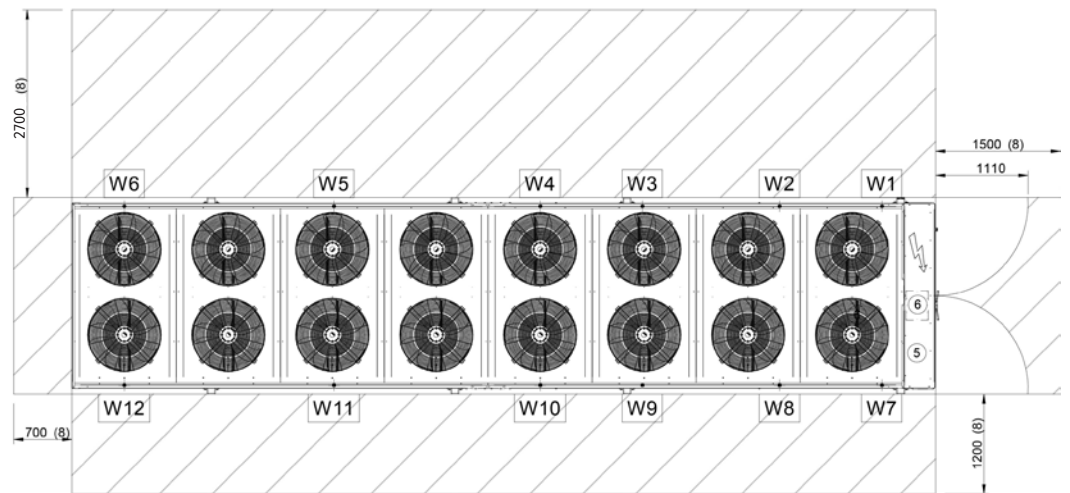
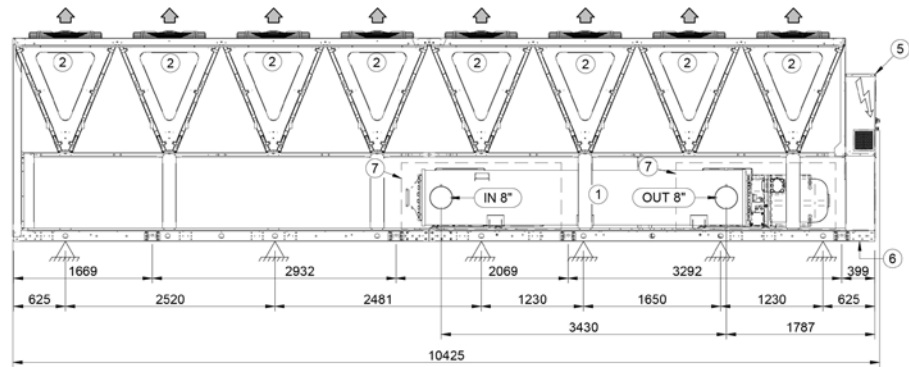
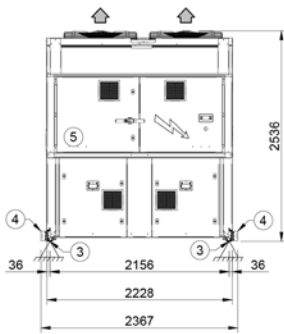

1. Internal exchanger (Evaporator)
2. Esternal exchanger (Condenser)
3. Unit fixing holes
4. Lifting brackets (Removable)
5. Electrical panel
6. Power input
7. Sound proof enclosure, only SC and EN version
8. Clearance access recommended

SIZE	580.2		
	ST	SC/EN	
Length	mm	10425	10425
Depth	mm	2228	2228
Height	mm	2536	2536
W1 Supporting point	kg	694	734
W2 Supporting point	kg	982	1107
W3 Supporting point	kg	597	597
W4 Supporting point	kg	1240	1404
W5 Supporting point	kg	464	464
W6 Supporting point	kg	277	277
W7 Supporting point	kg	544	558
W8 Supporting point	kg	896	938
W9 Supporting point	kg	1069	1069
W10 Supporting point	kg	1048	1105
W11 Supporting point	kg	449	449
W12 Supporting point	kg	280	280
Operating weight	kg	8540	8982
Shipping weight	kg	7459	7899

The presence of optional accessories may result in a substantial variation of the weights shown in the table. Fan diffusers are separately supplied.

FOR OVER 30 YEARS WE HAVE BEEN
OFFERING SOLUTIONS TO ENSURE
SUSTAINABLE COMFORT AND THE WELL-
BEING OF PEOPLE AND THE ENVIRONMENT

www.clivet.com

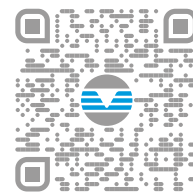

sale and assistance

ELFOENERGY MAGNUM - BT19F016GB-04



CLIVET SPA
Via Camp Lonc 25, Z.I. Villapaiera
32032 Feltre (BL) - Italy
Tel. +39 0439 3131 - Fax +39 0439 313300
info@clivet.it

MideaGroup
humanizing technology